



76957





 **FR**
DONNEZ
OU
RECYCLEZ

 OU  OU 

ASSOCIATION MAGASIN DÉCHÈTERIE

Adresses sur quefairedemesdechets.fr



LEGO.com/sustainable-packaging



BUILDER



Apple and the Apple logo are trademarks of Apple Inc., registered in the U.S. and other countries and regions. App Store is a service mark of Apple Inc. Google Play and the Google Play logo are trademarks of Google LLC. Tencent and the Tencent logo are trademarks of Tencent Inc.

Q [LEGO.com/devicecheck](https://www.lego.com/devicecheck)

EN Ask parents' permission before going online | **DE** Eltern um Erlaubnis bitten, bevor du online gehst | **FR** Demande l'autorisation d'un parent avant d'aller en ligne | **IT** Chiedi il permesso ai tuoi genitori prima di andare online | **ES** Pídeles permiso a tus papás antes de conectarte a Internet | **PT** Pede autorização aos pais antes de acederes online | **ZH** 上网前应先征得父母的同意 | **PL** Poproś rodziców o zgodę, zanim wejdiesz do Internetu | **CS** Než půjdeš na internet, požádej rodiče o svolení | **SK** Skôr než pôjdeš na internet, vypýtaj si povolenie od rodičov | **HU** Kérj szülői engedélyt, mielőtt online csatlakoznál! | **RO** Cere permisiunea părinților înainte de a te conecta online | **BG** Поискайте разрешение от родител, преди да влезете онлайн | **LV** Pirms došanās tiešsaistē palūdz atļauju vecākiem | **ET** Enne Interneti kasutamist küsi vanematelt luba | **LT** Prieš prisijungdami prie interneto, atsilkauskite tėvų

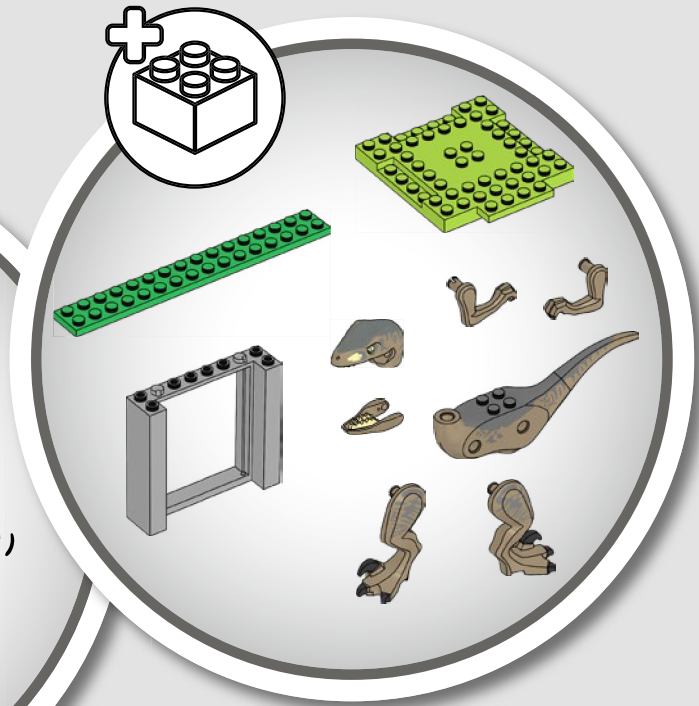

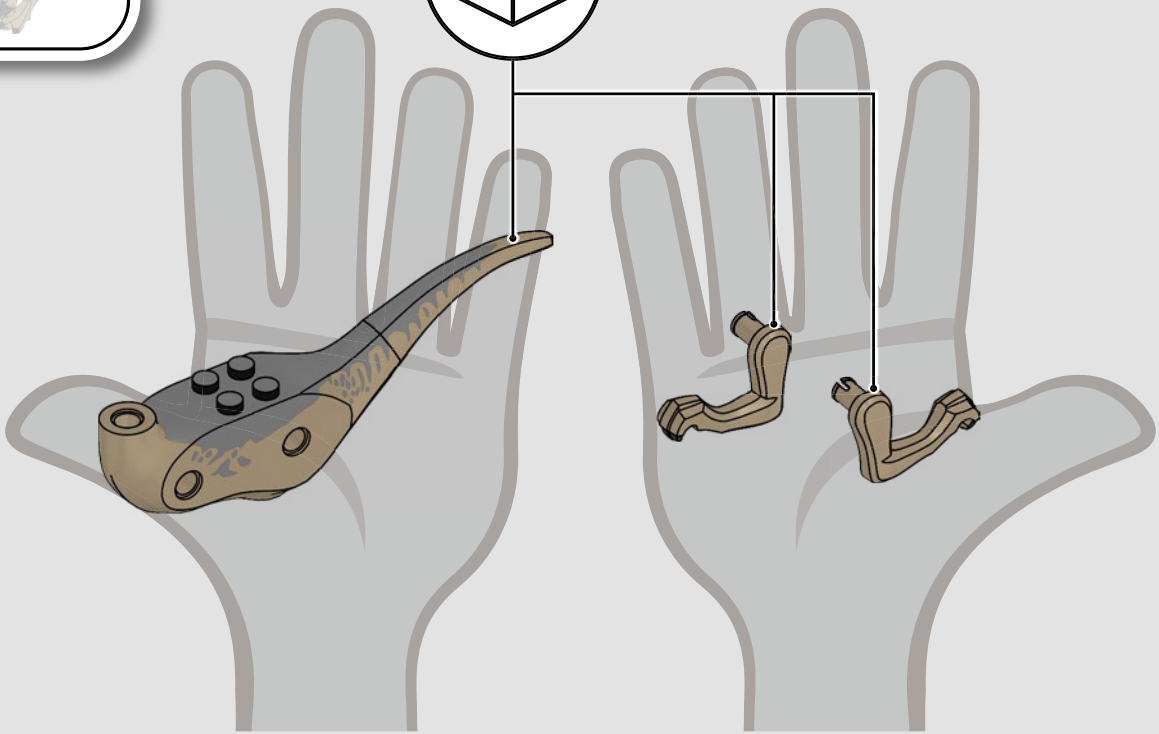
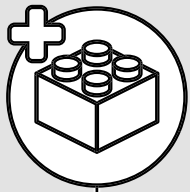

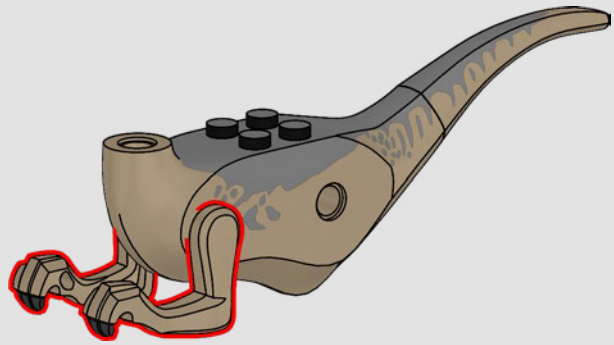
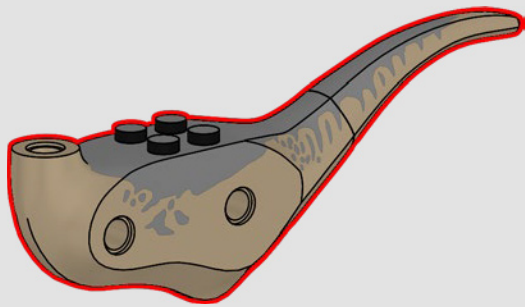

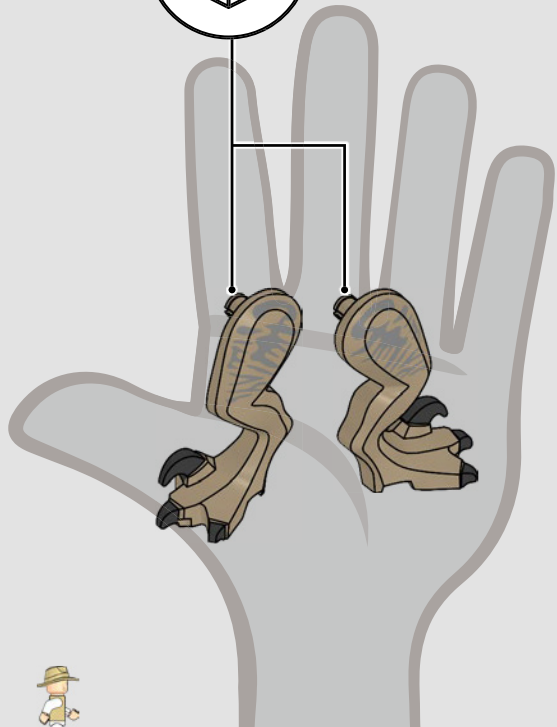

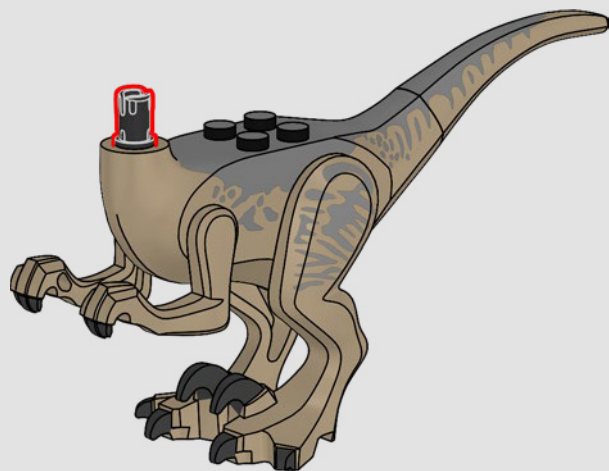
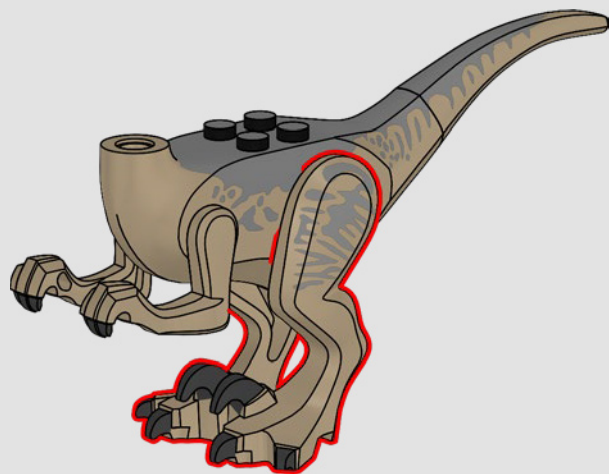

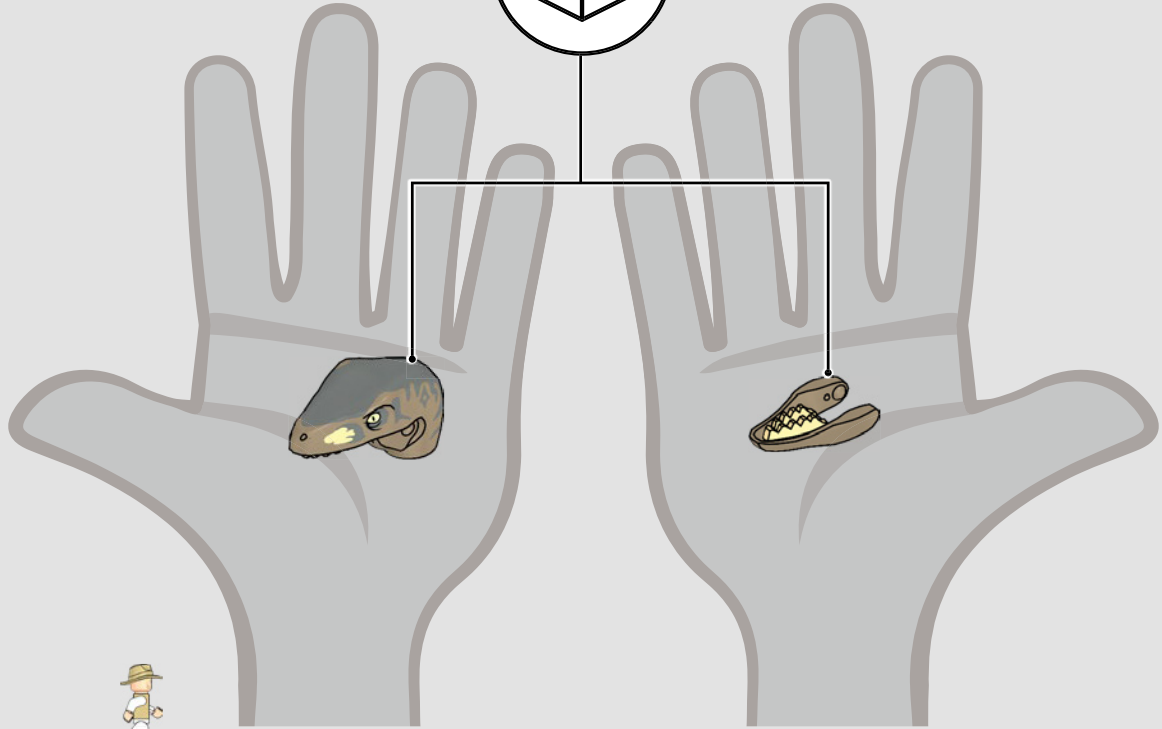
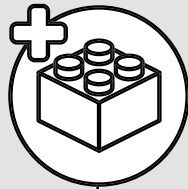



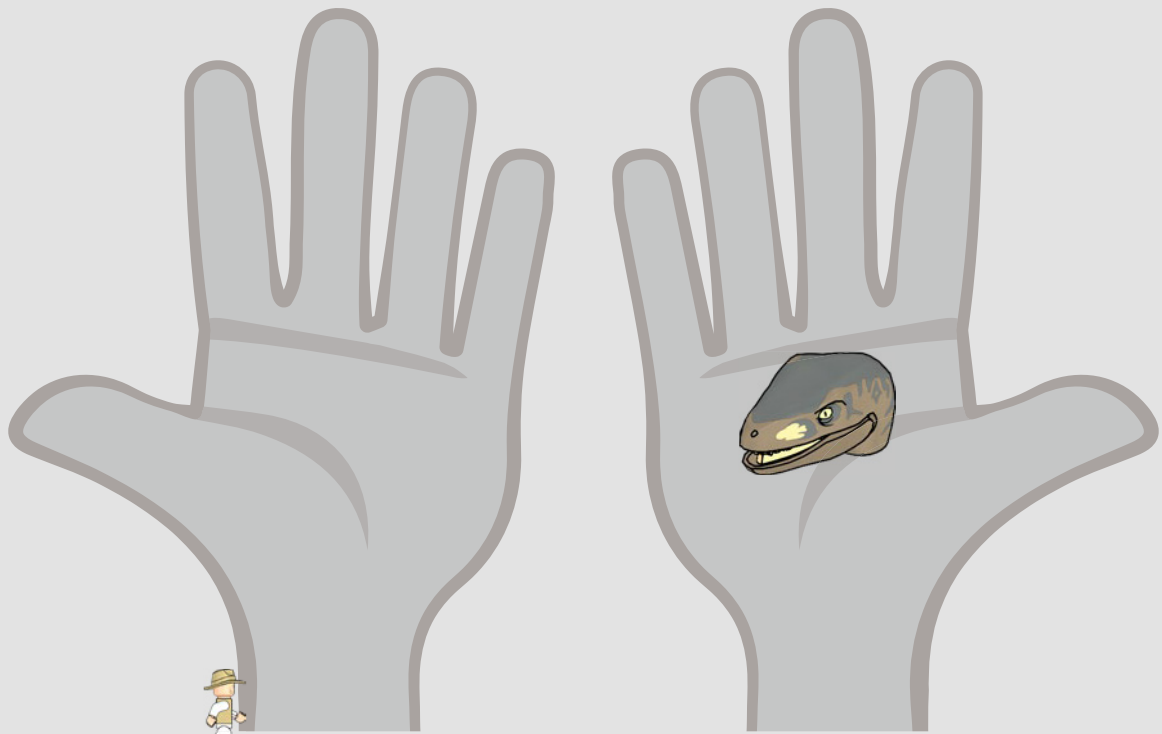



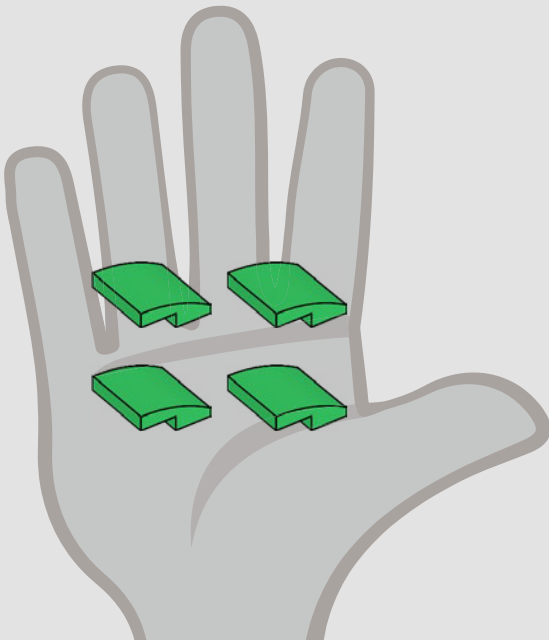
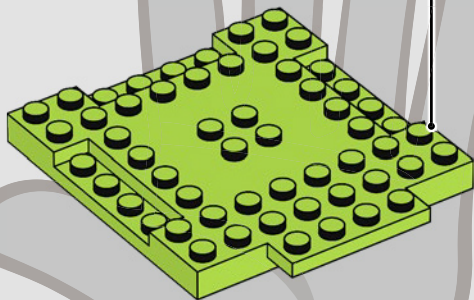
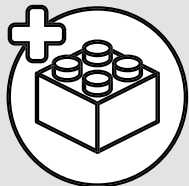
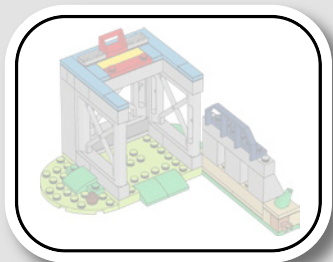

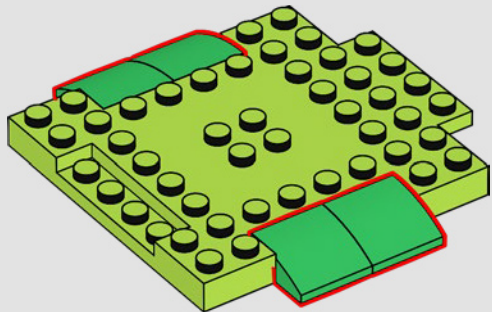
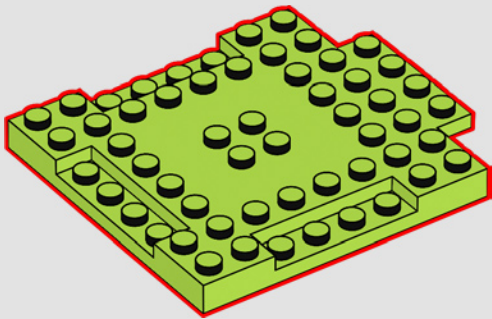

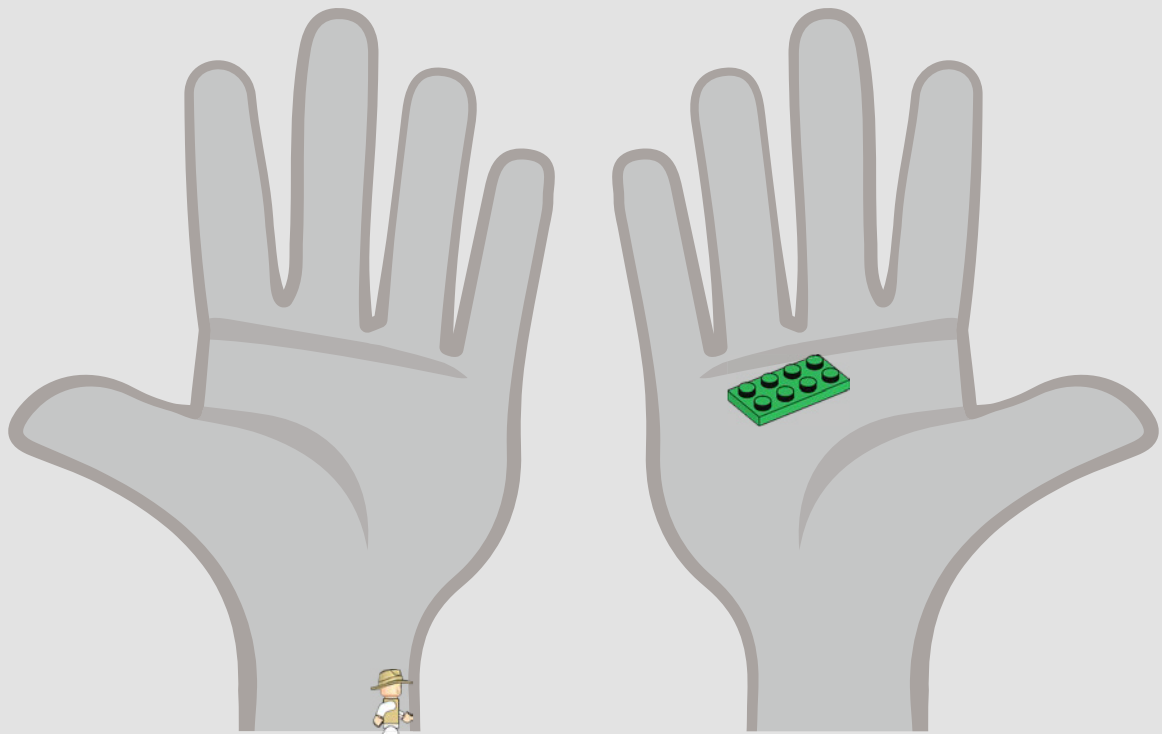

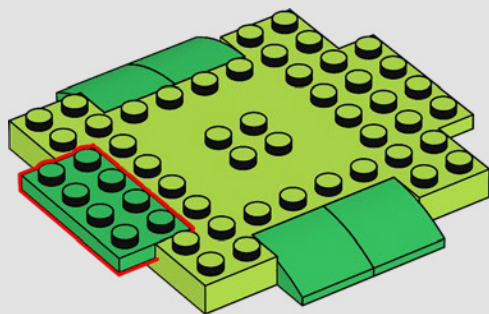

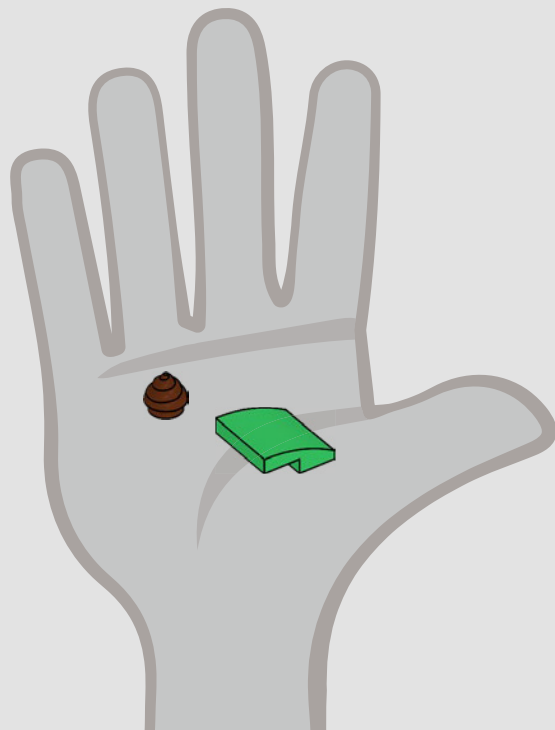
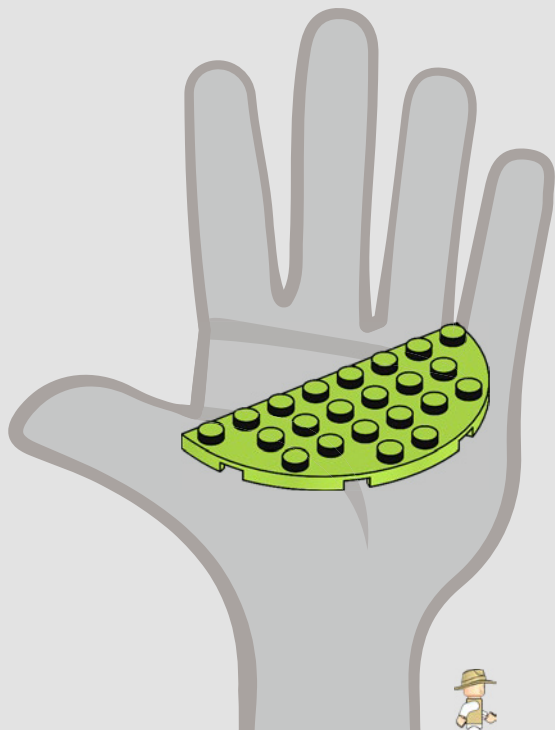

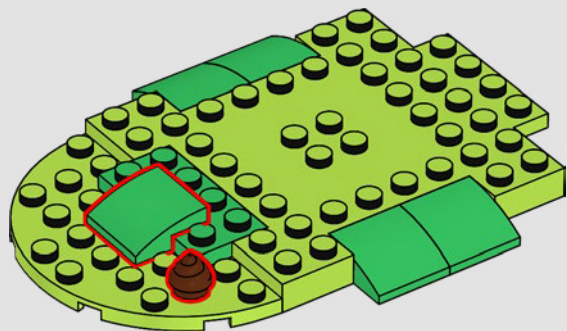
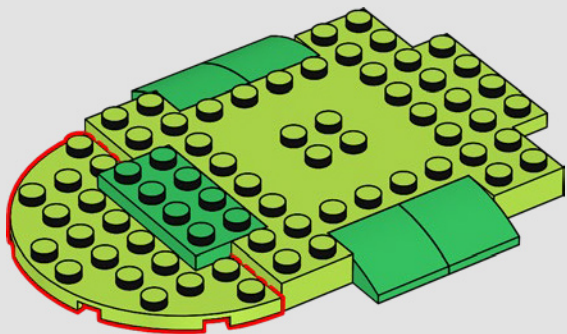

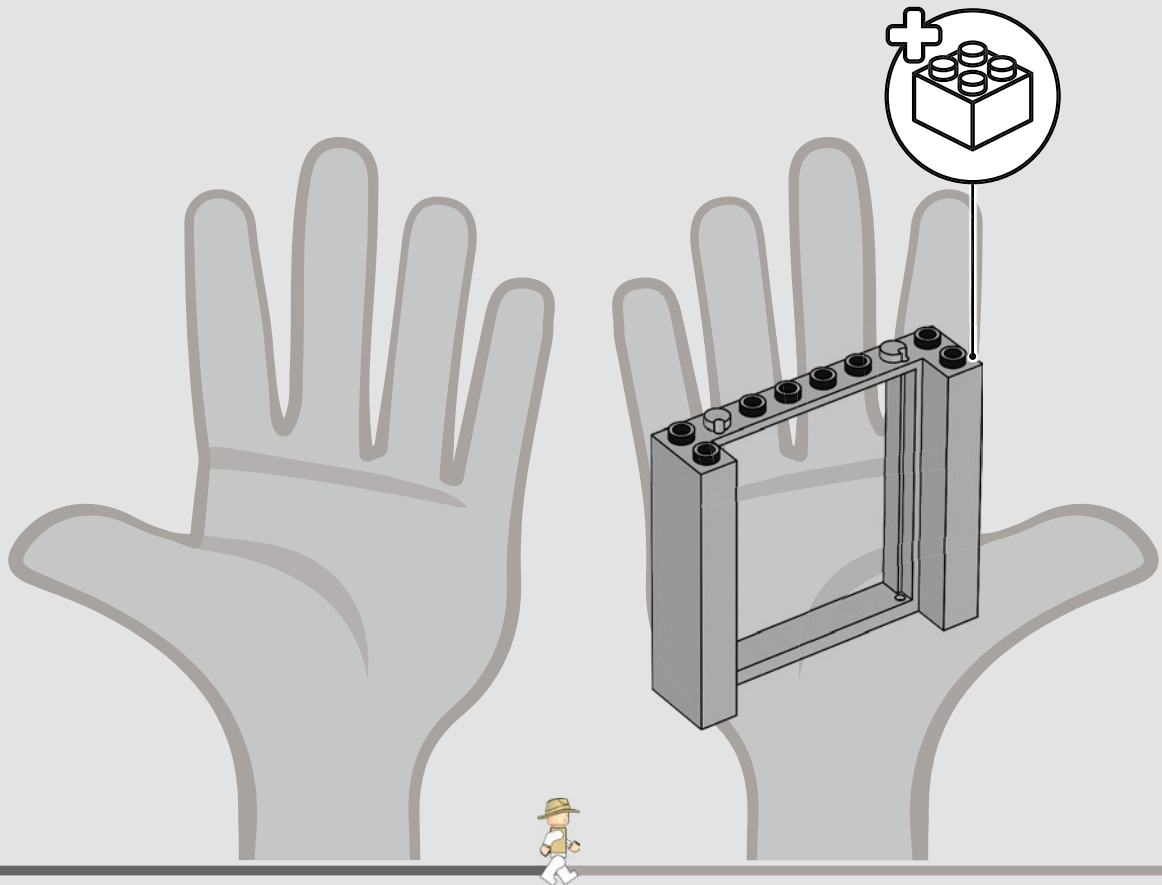

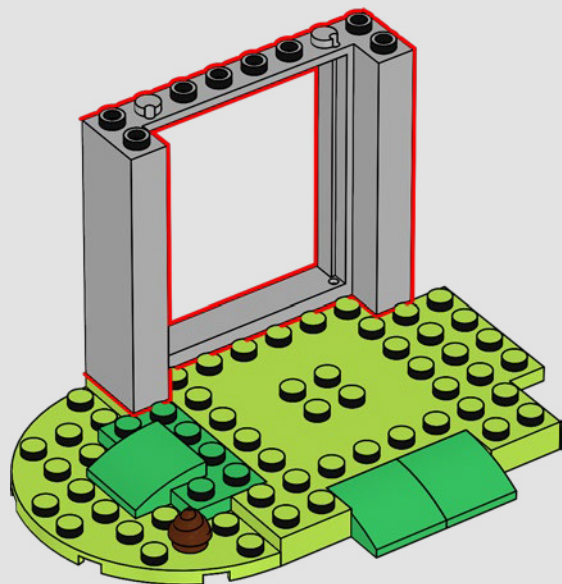

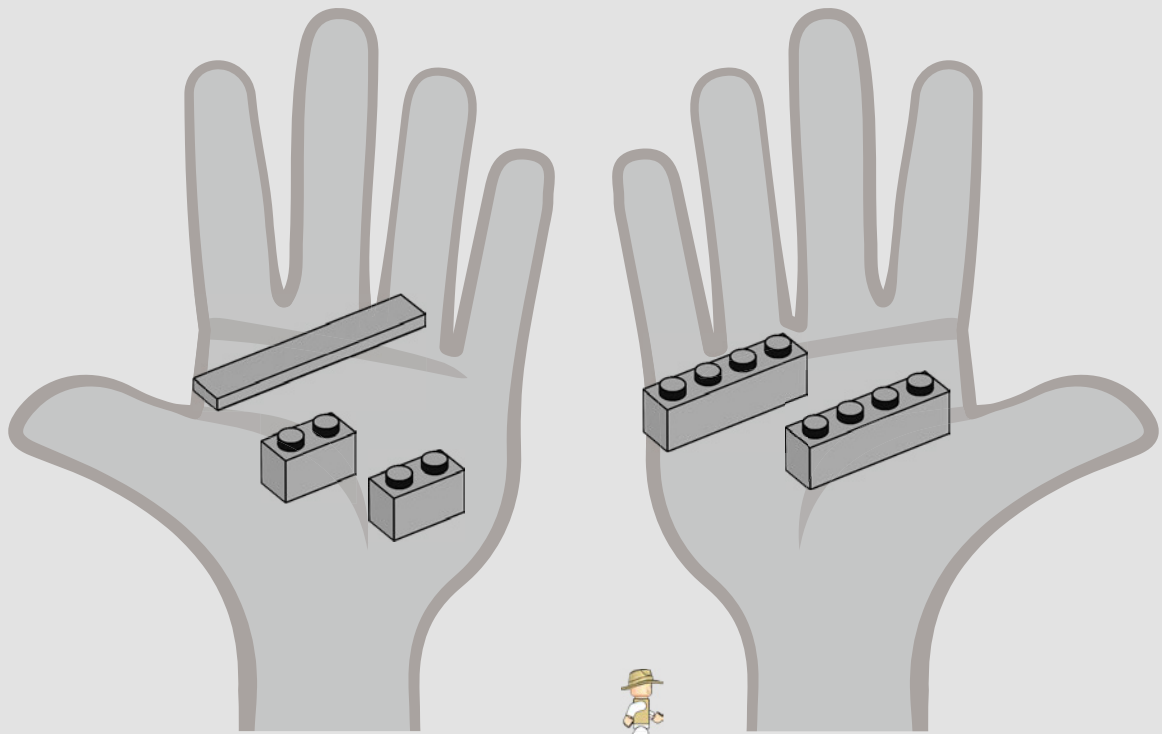

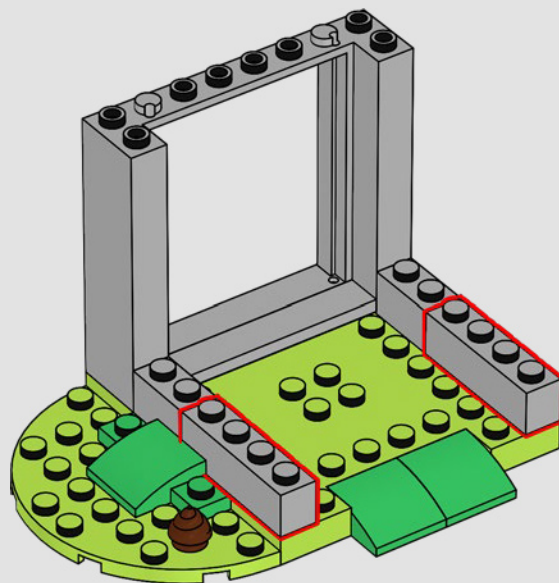
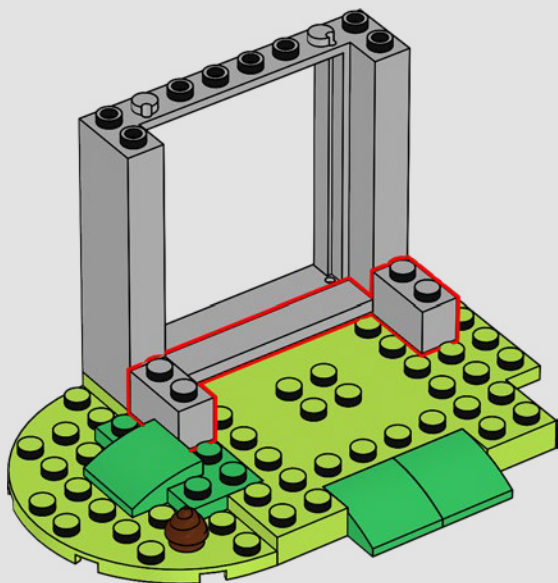

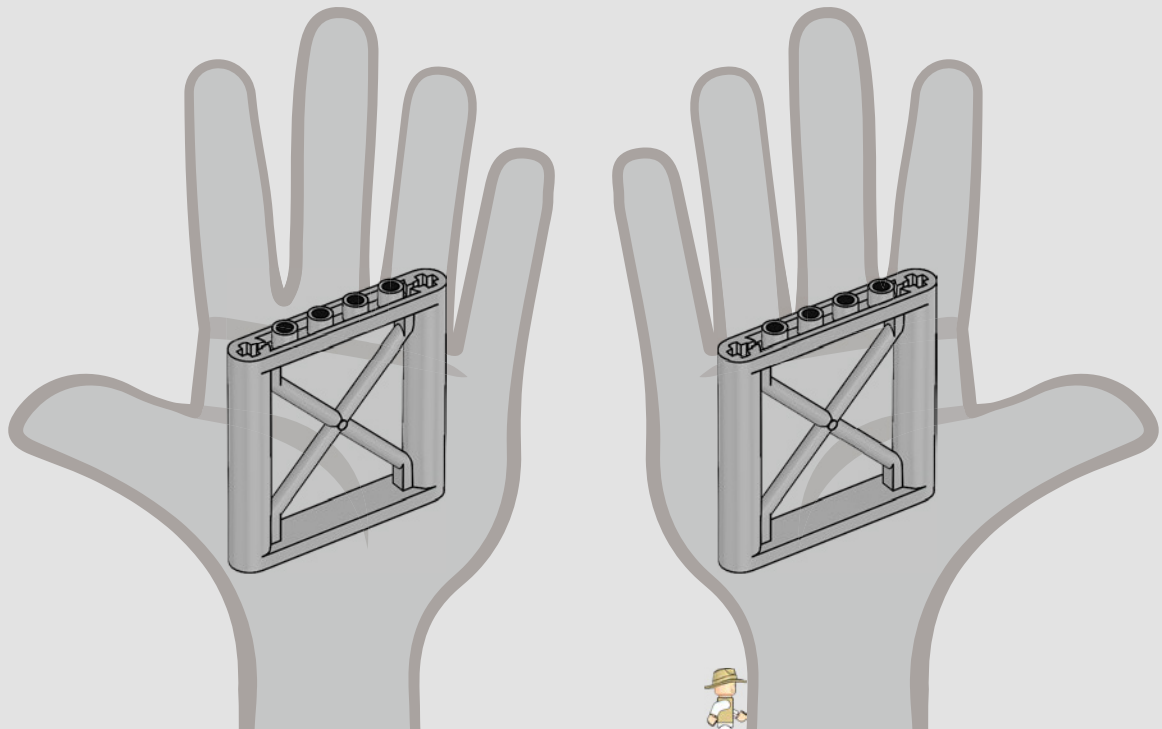

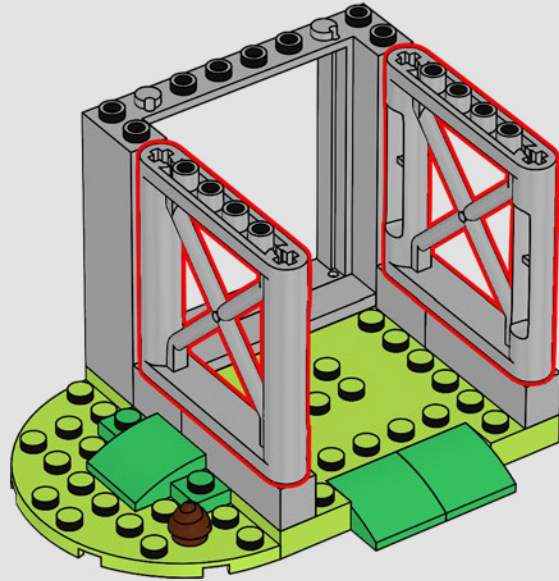

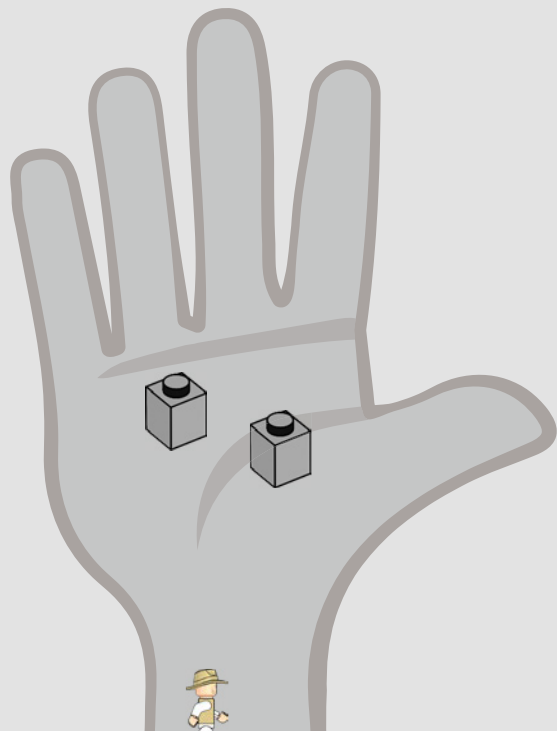
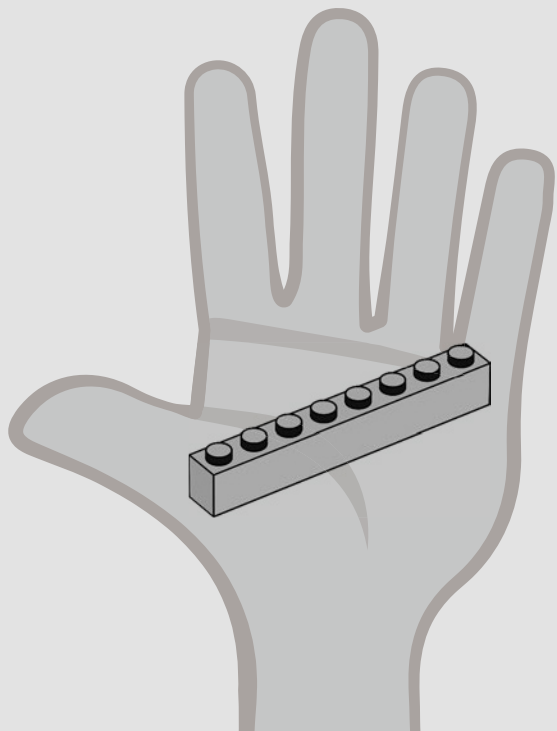

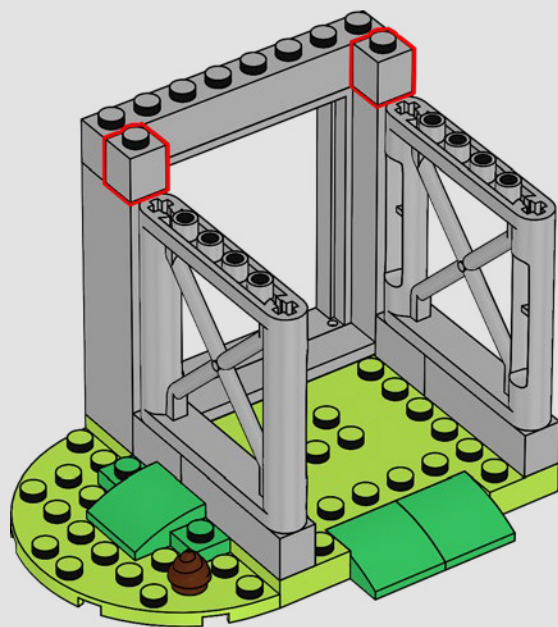
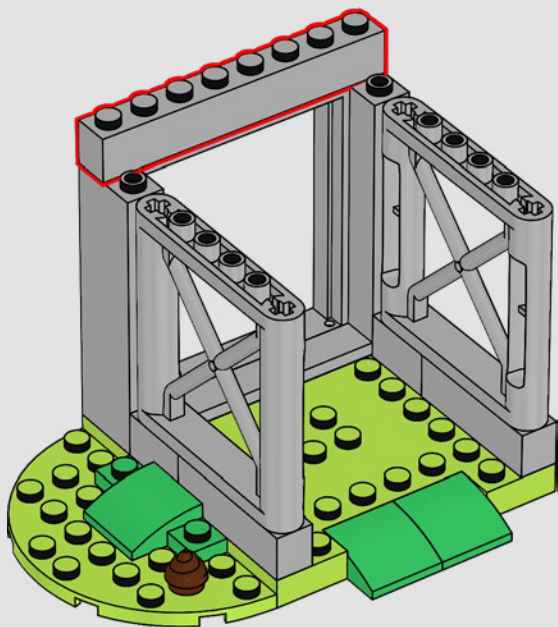

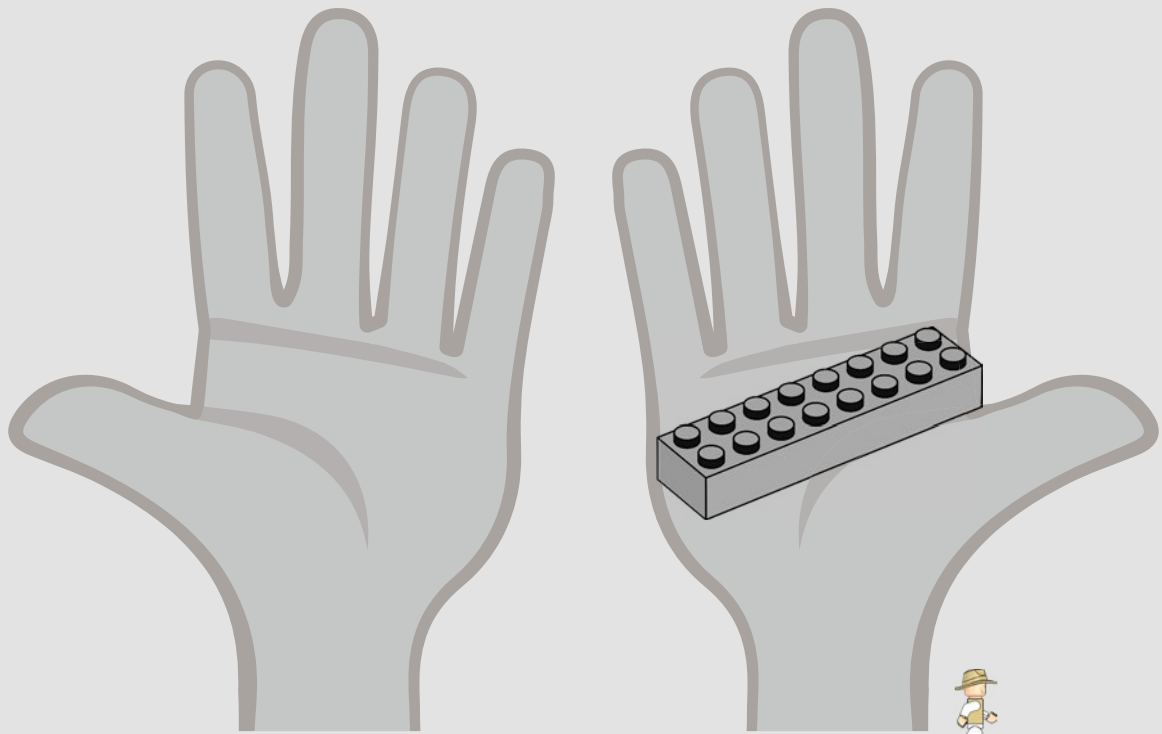

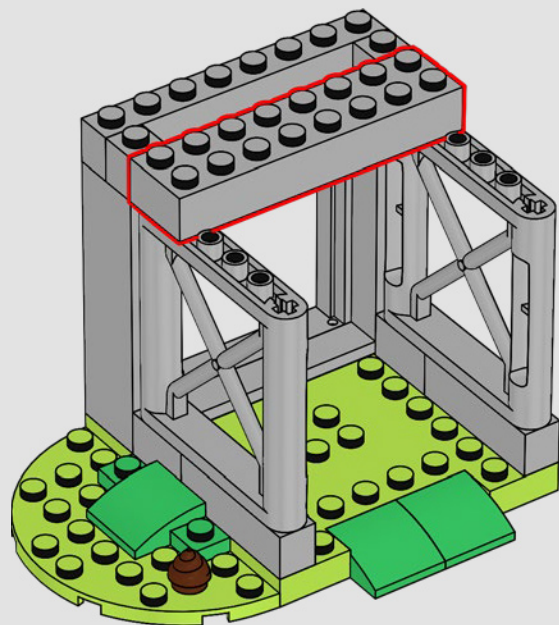

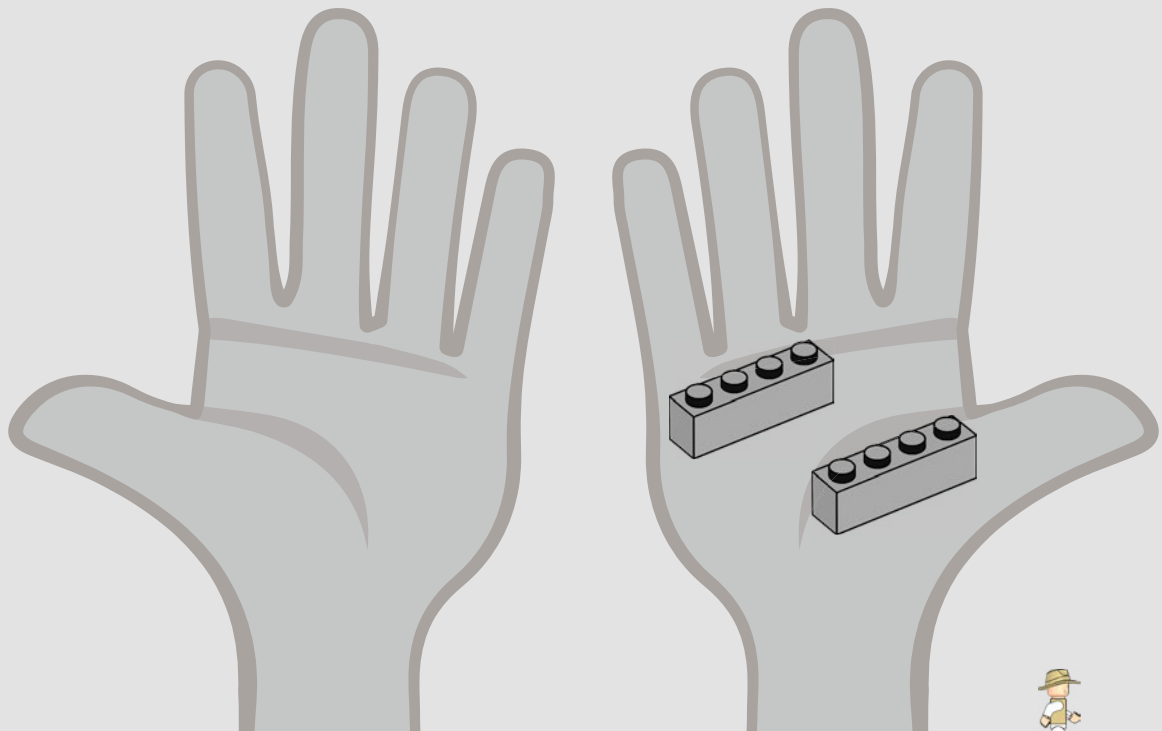

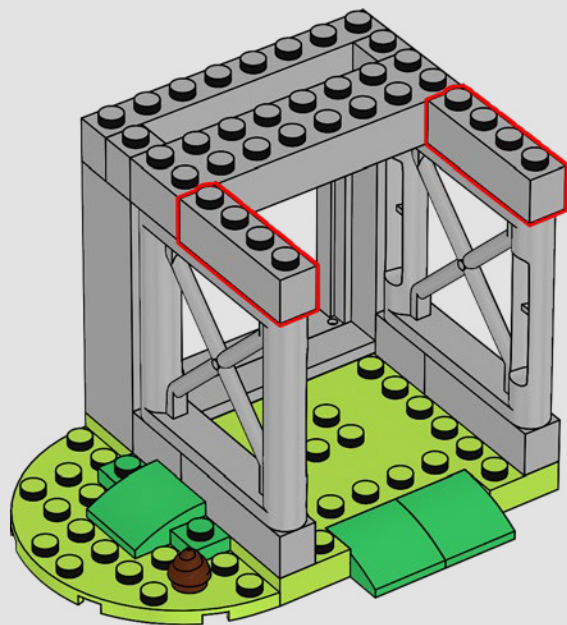

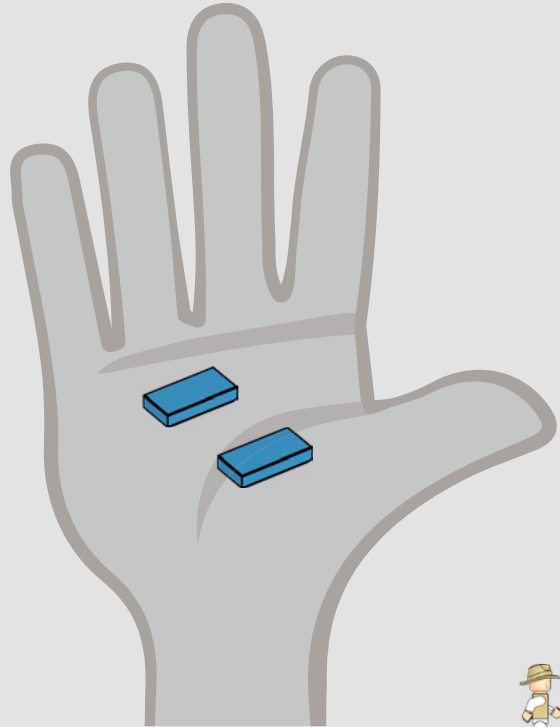
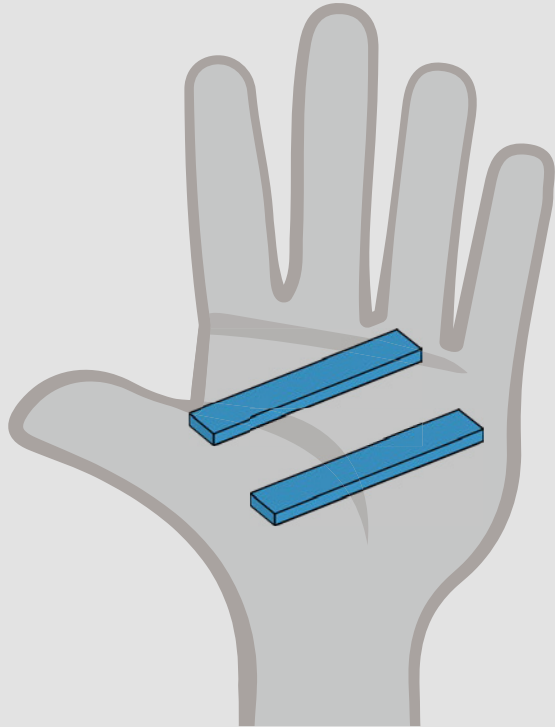

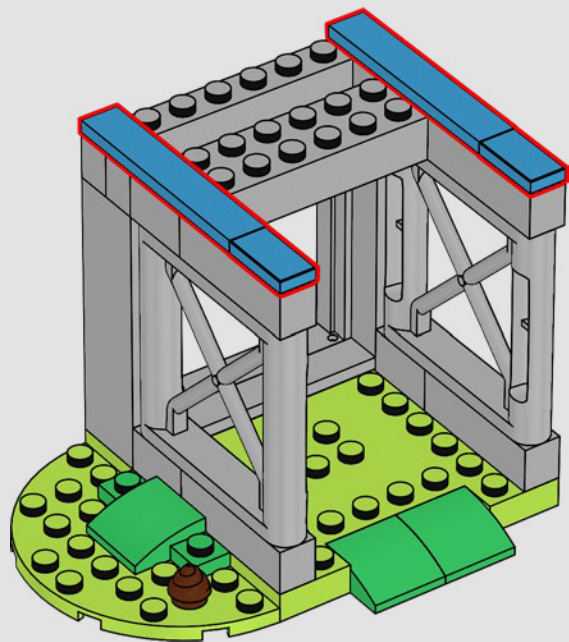

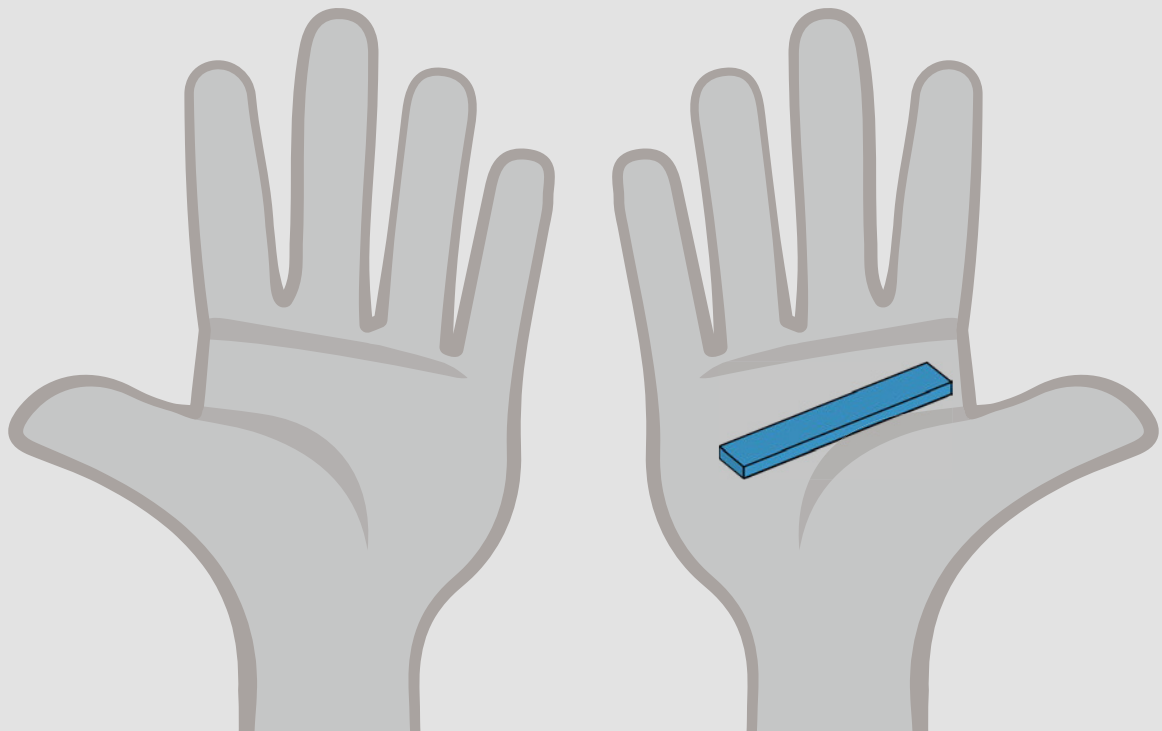

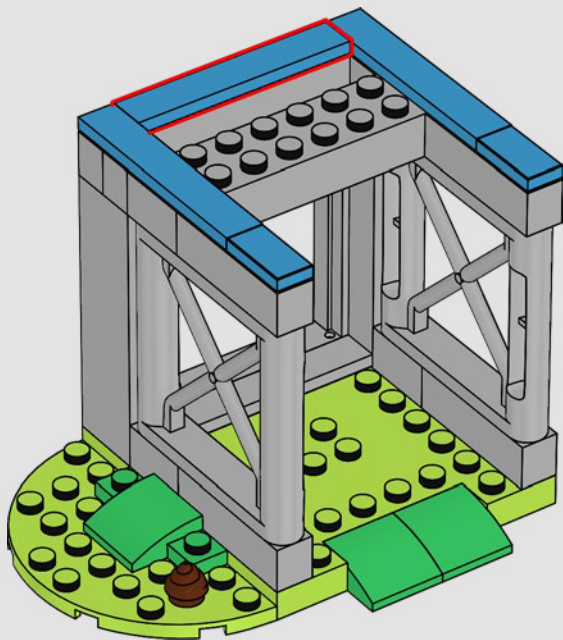

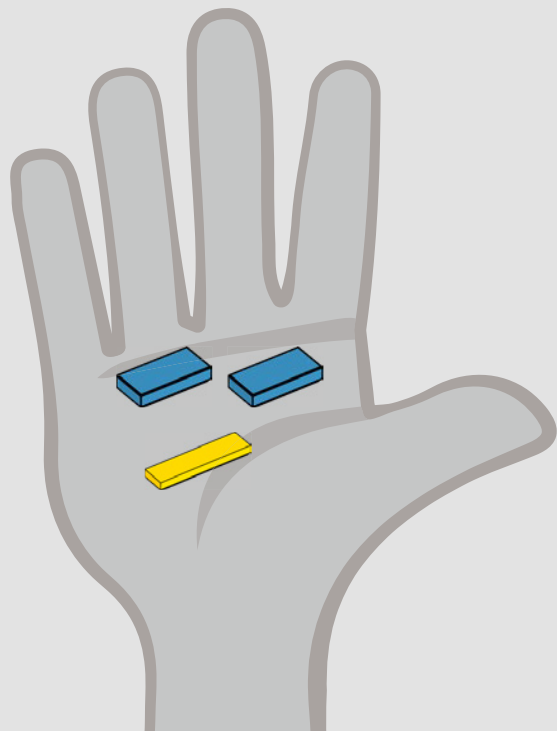
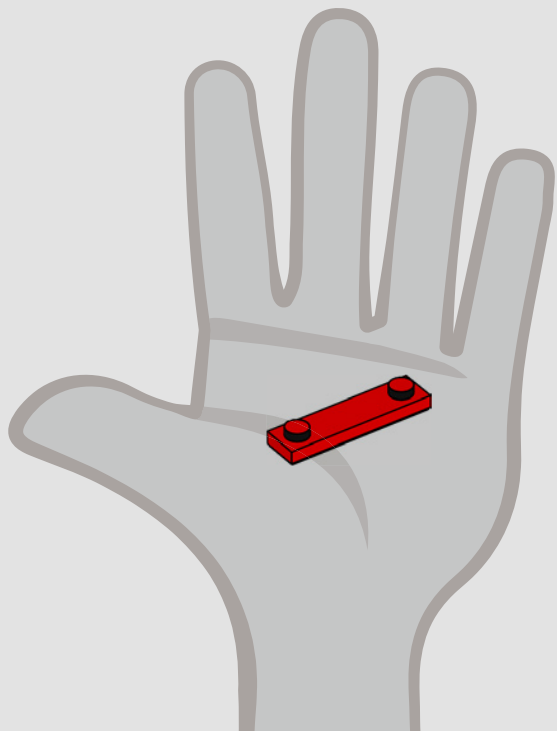

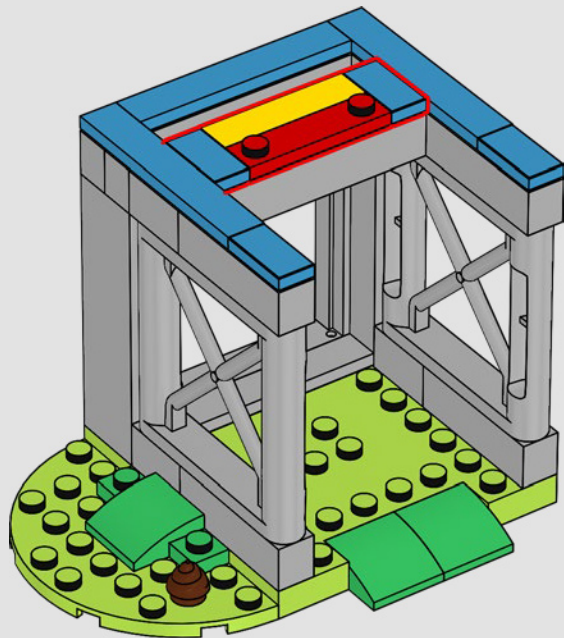

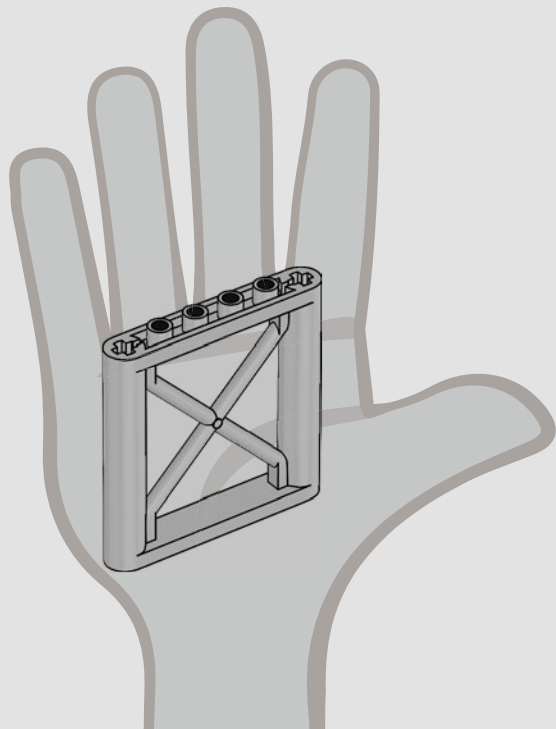
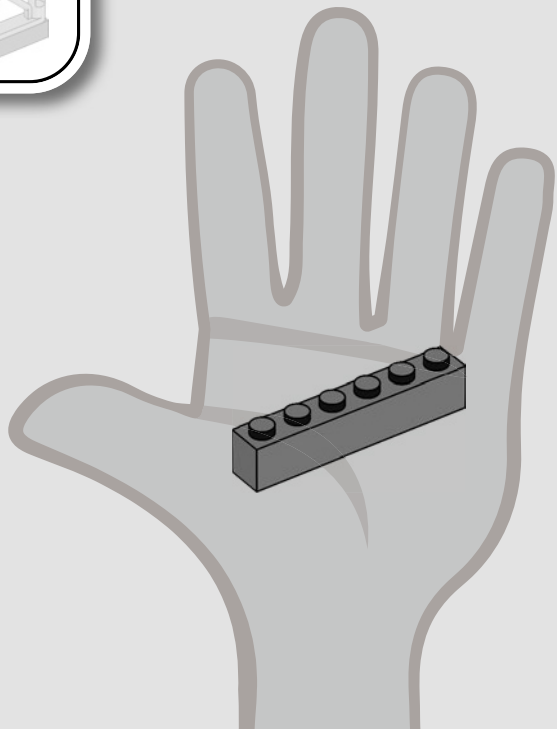
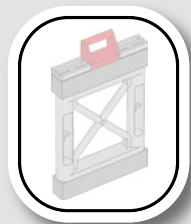

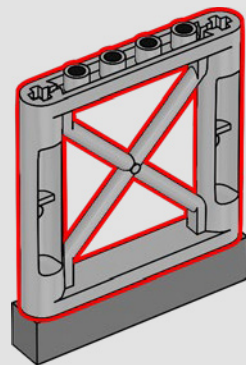
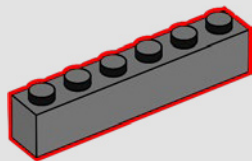

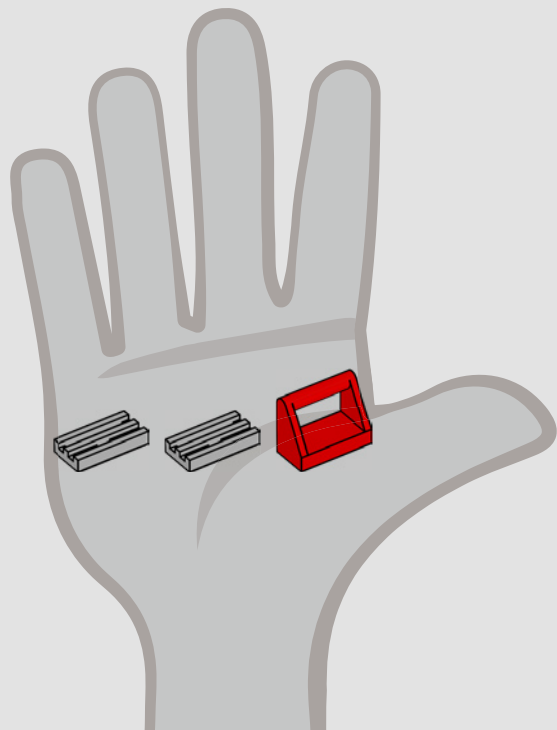
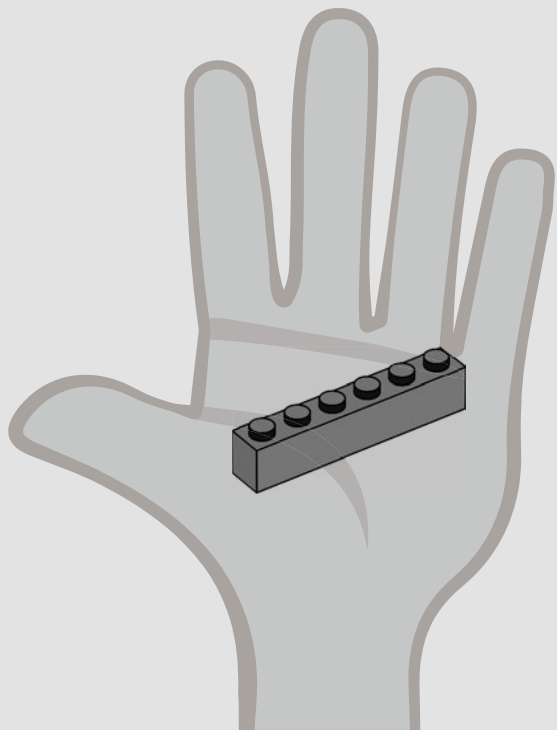

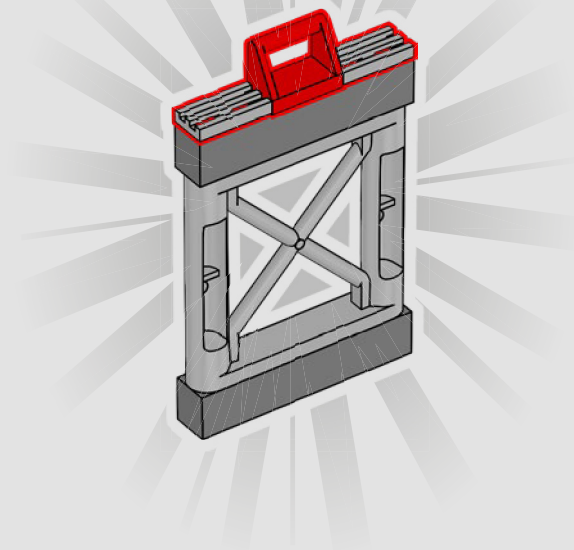
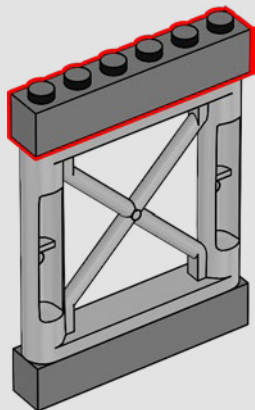

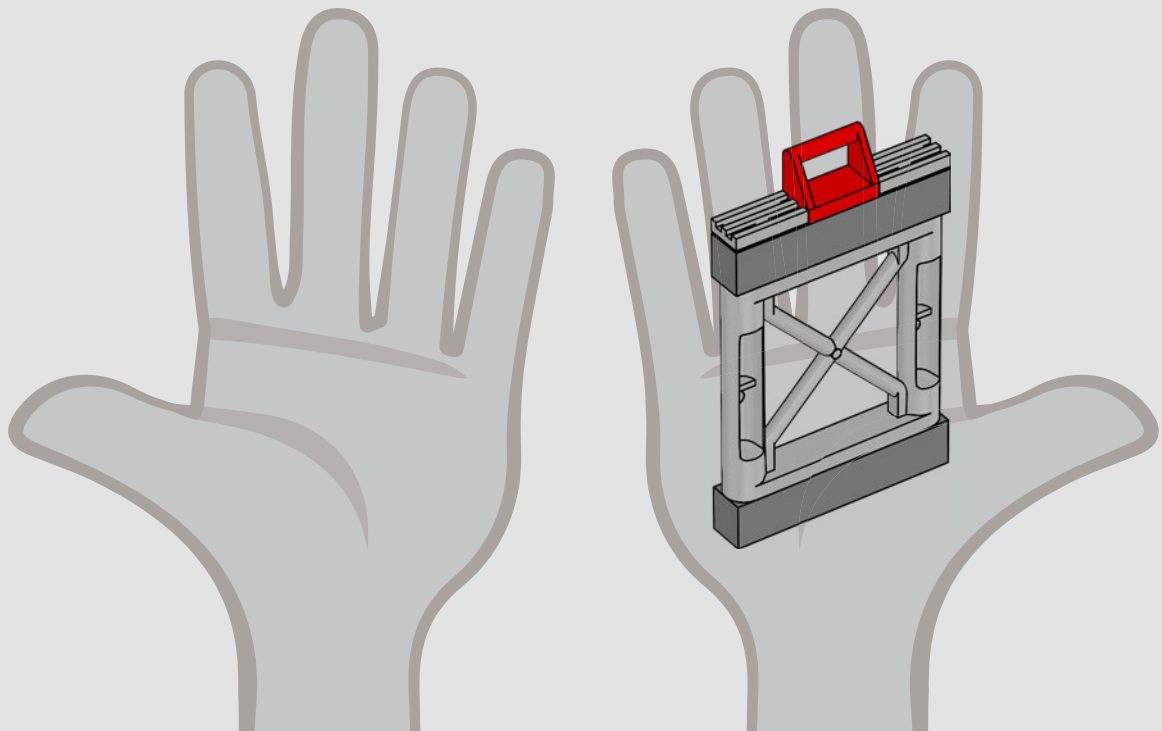

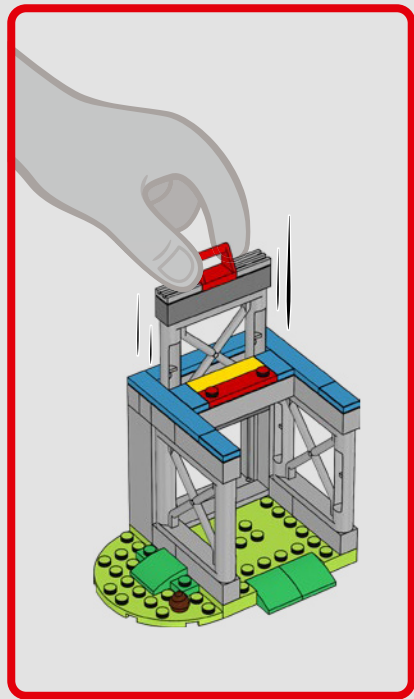
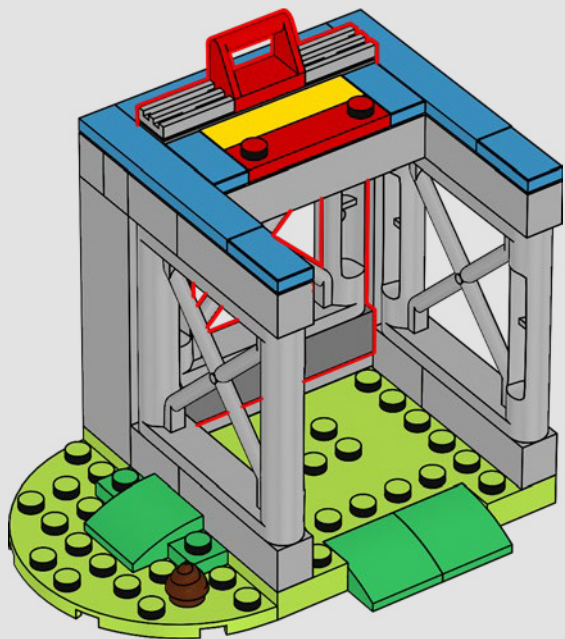

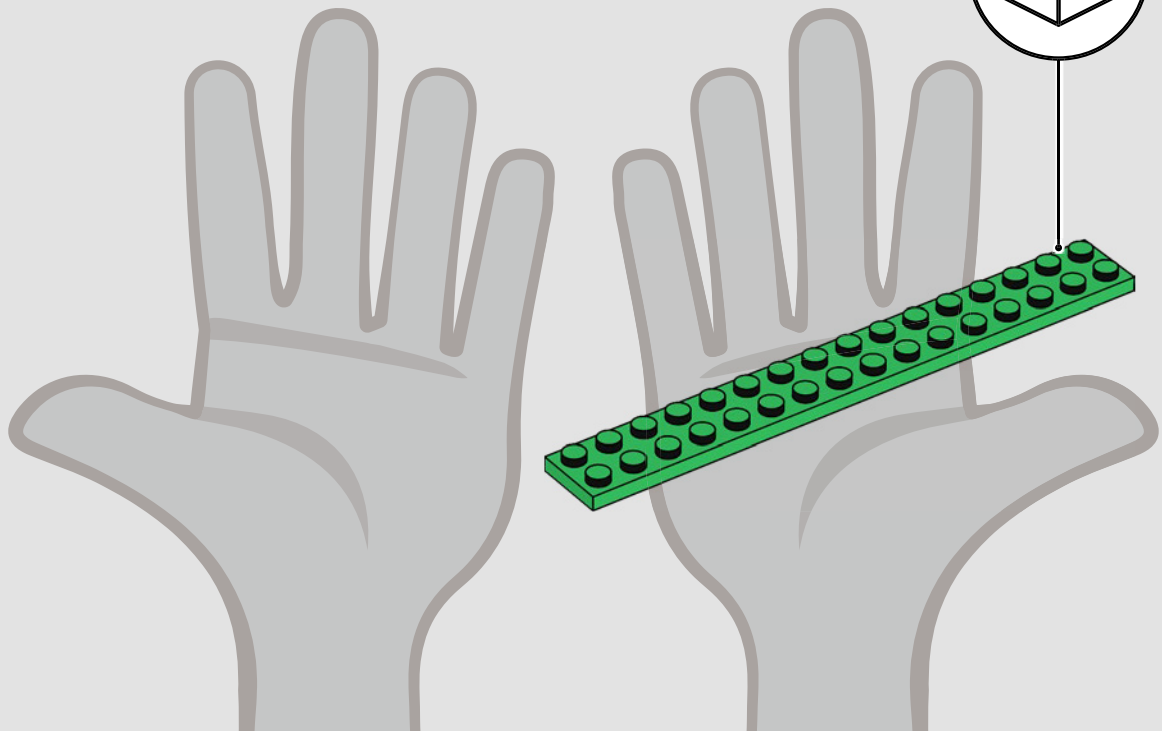

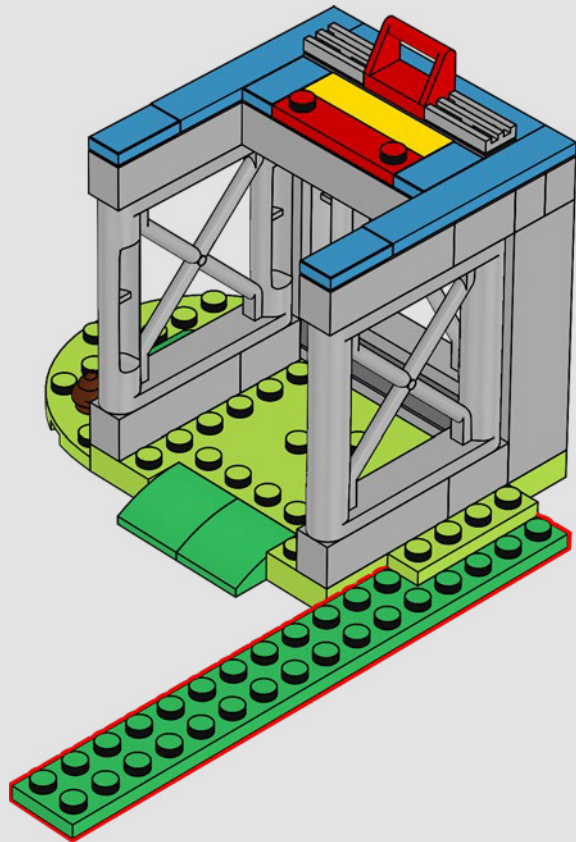

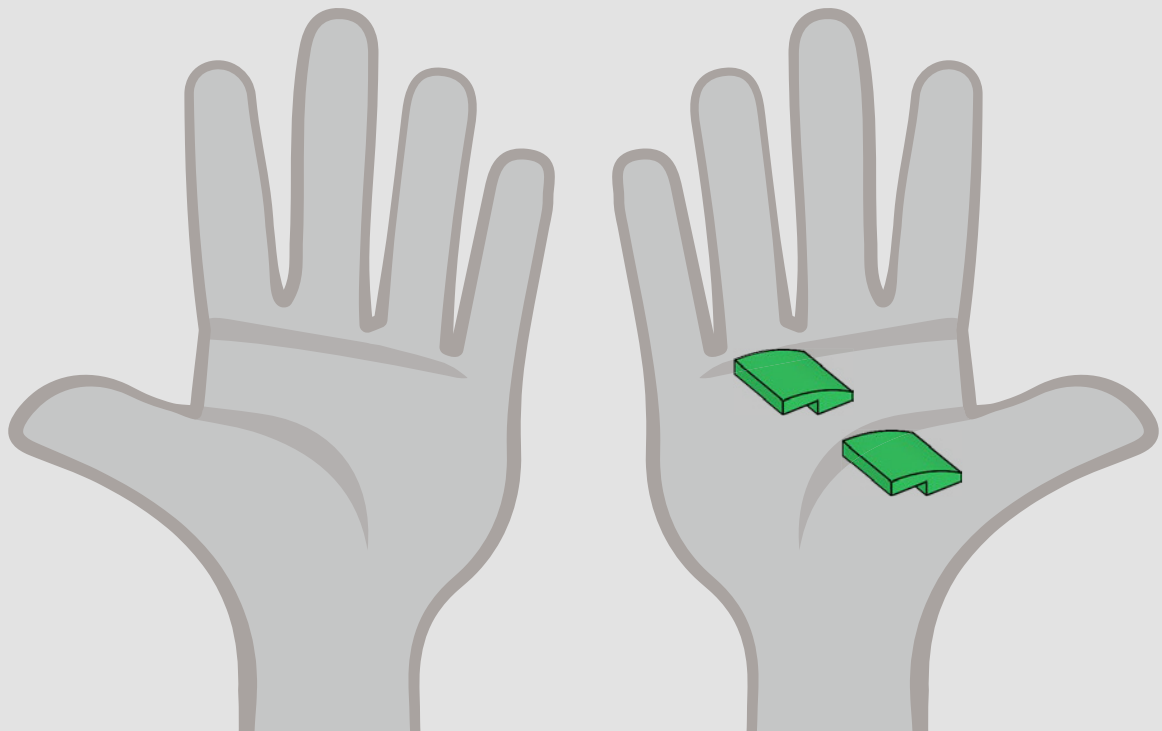

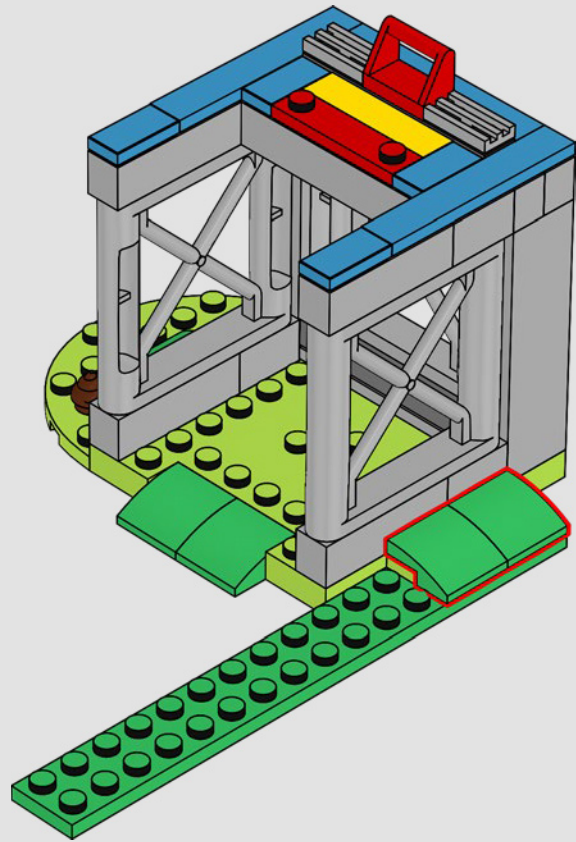

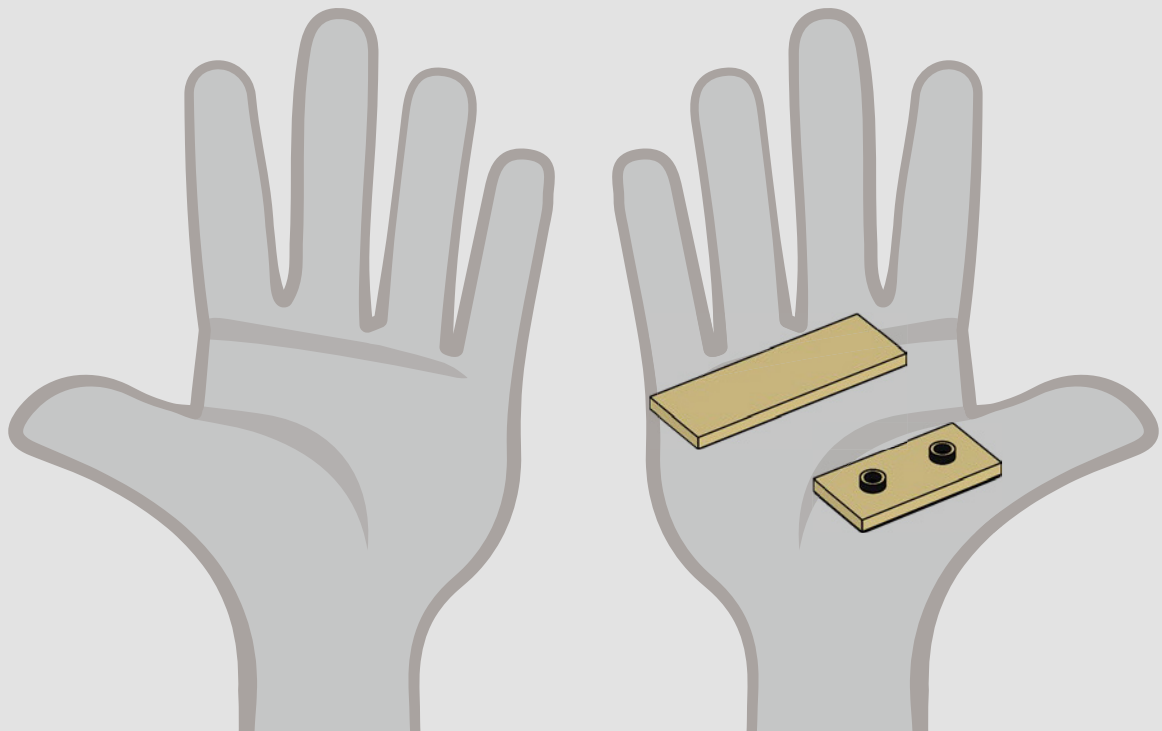

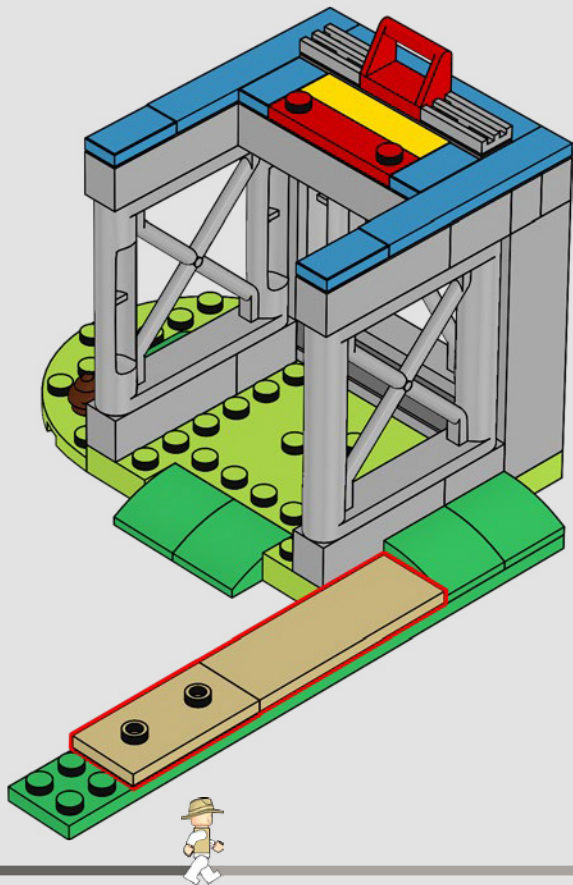

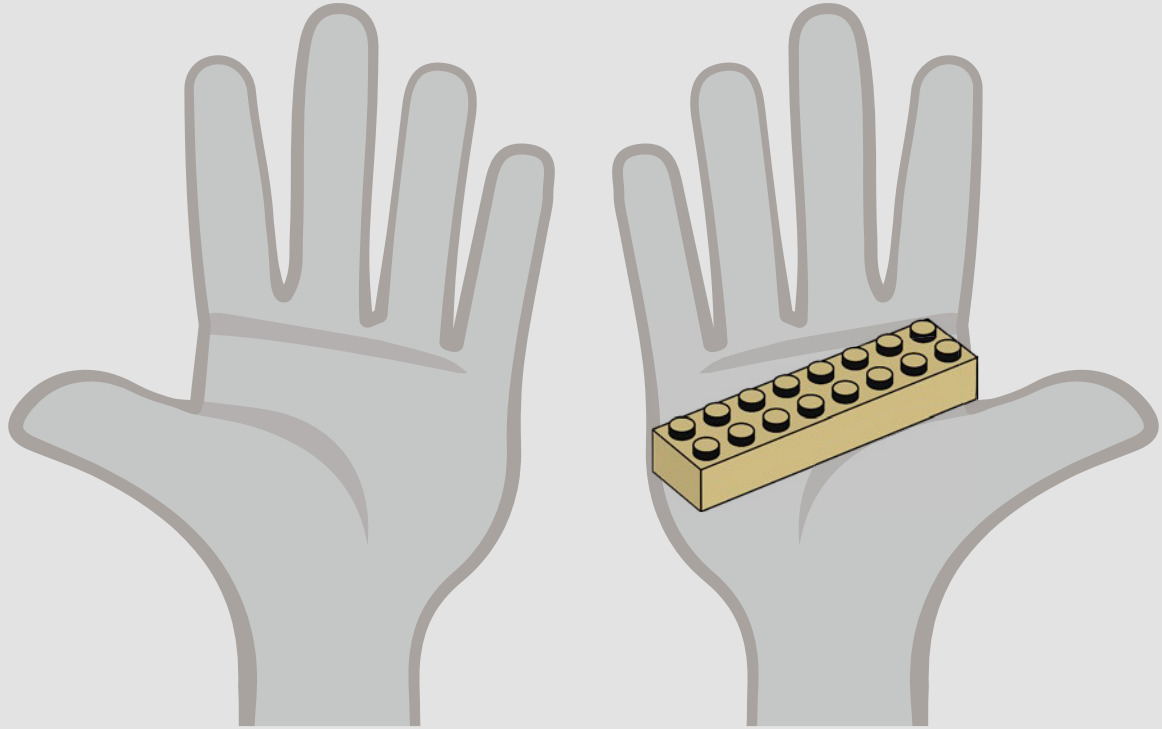

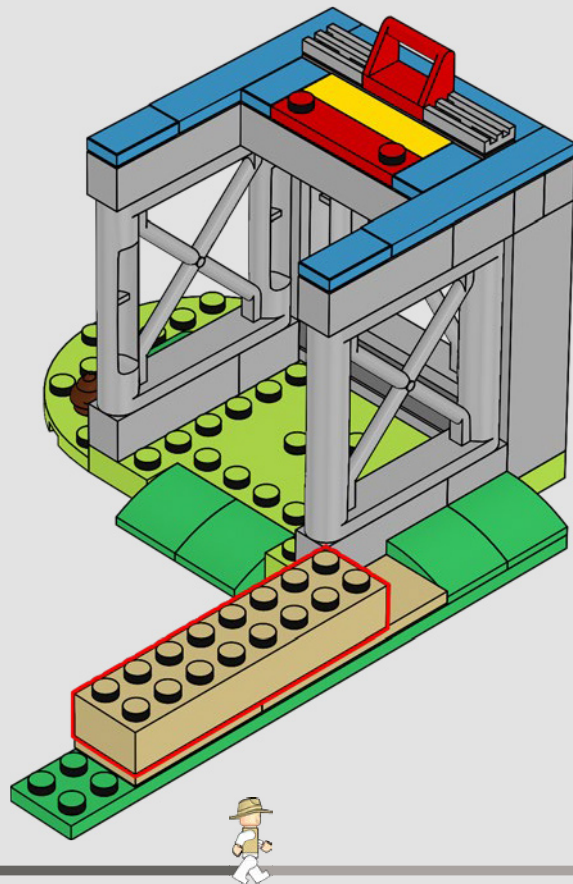

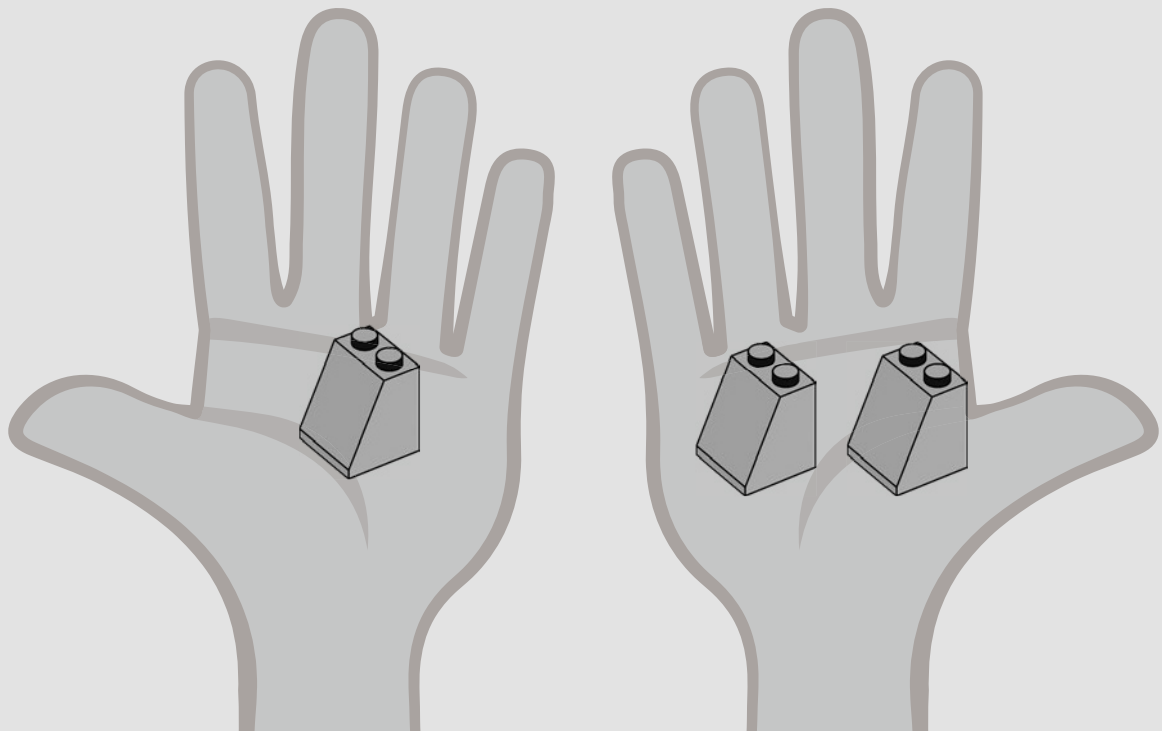

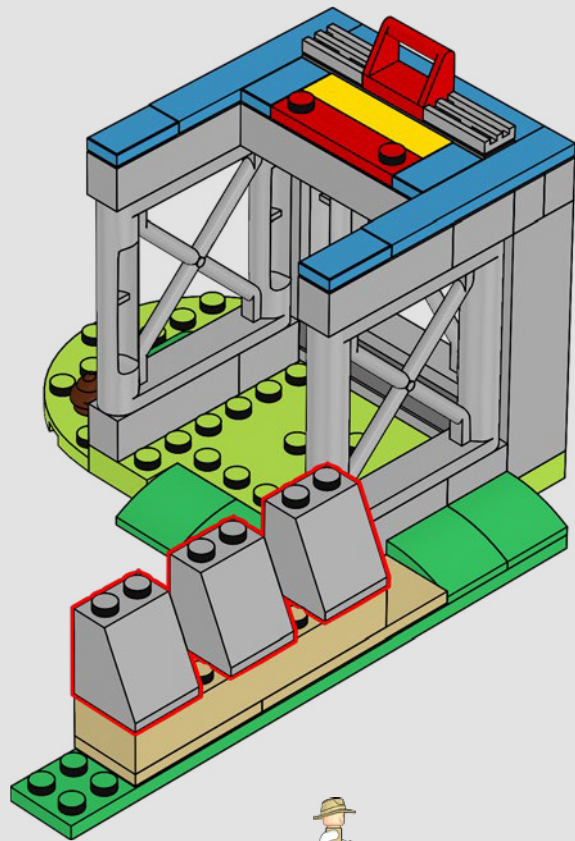

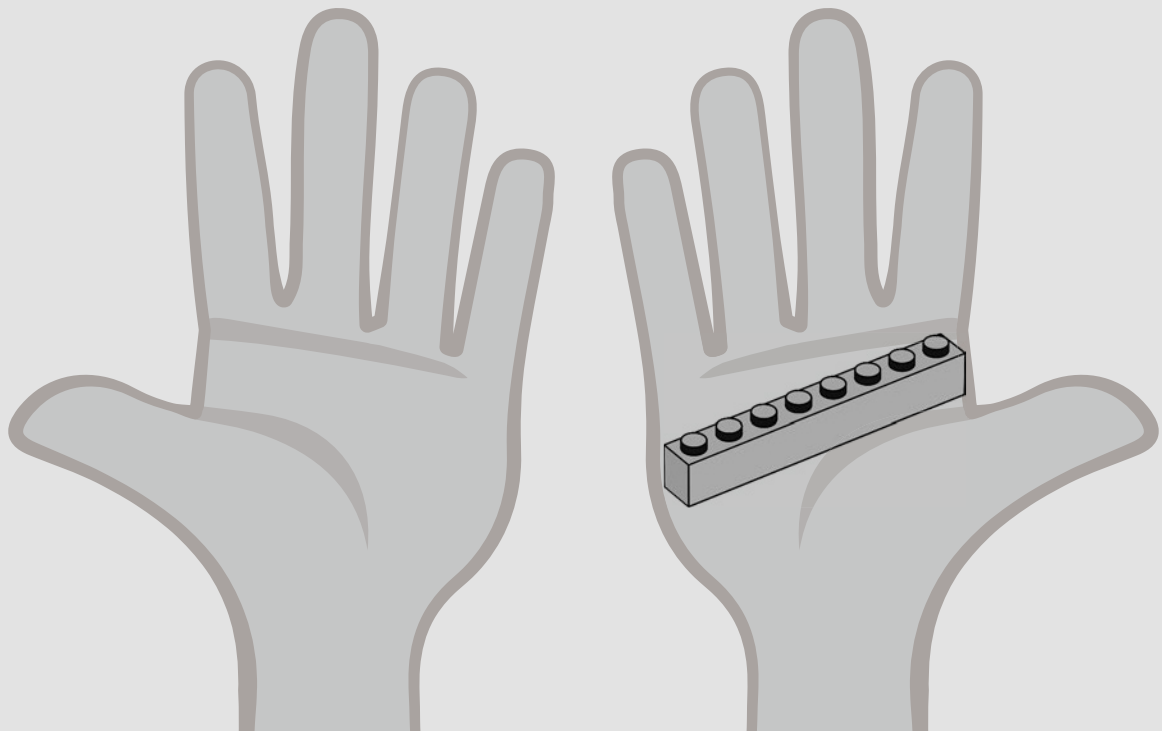

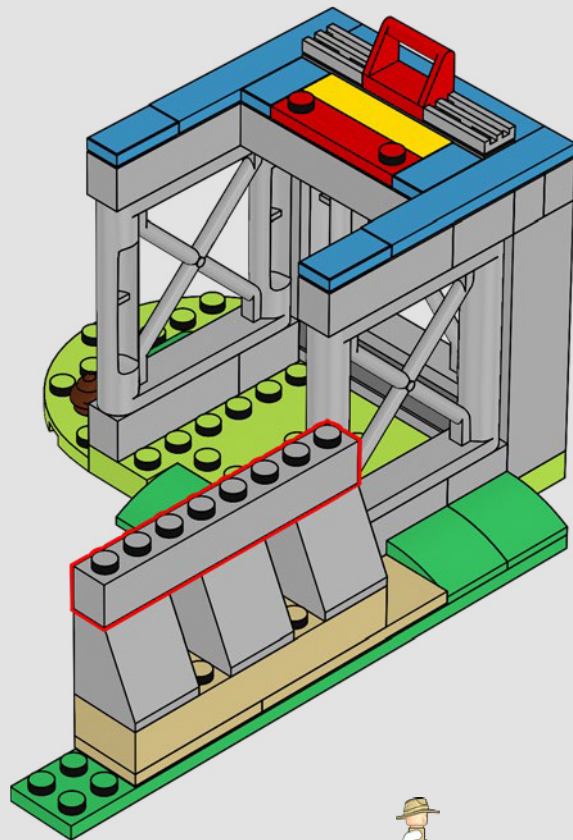

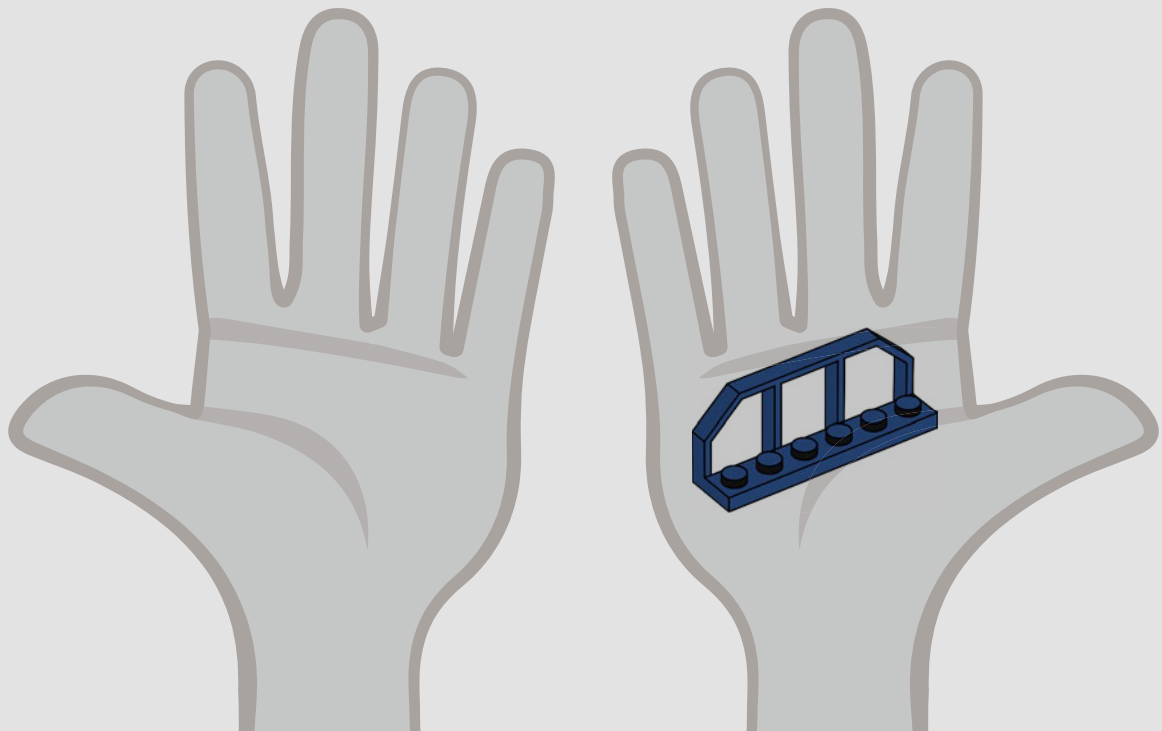

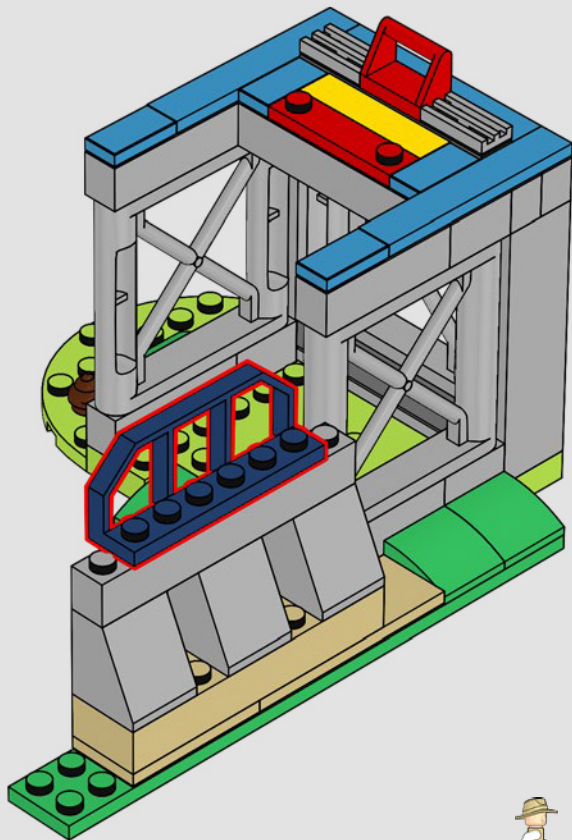

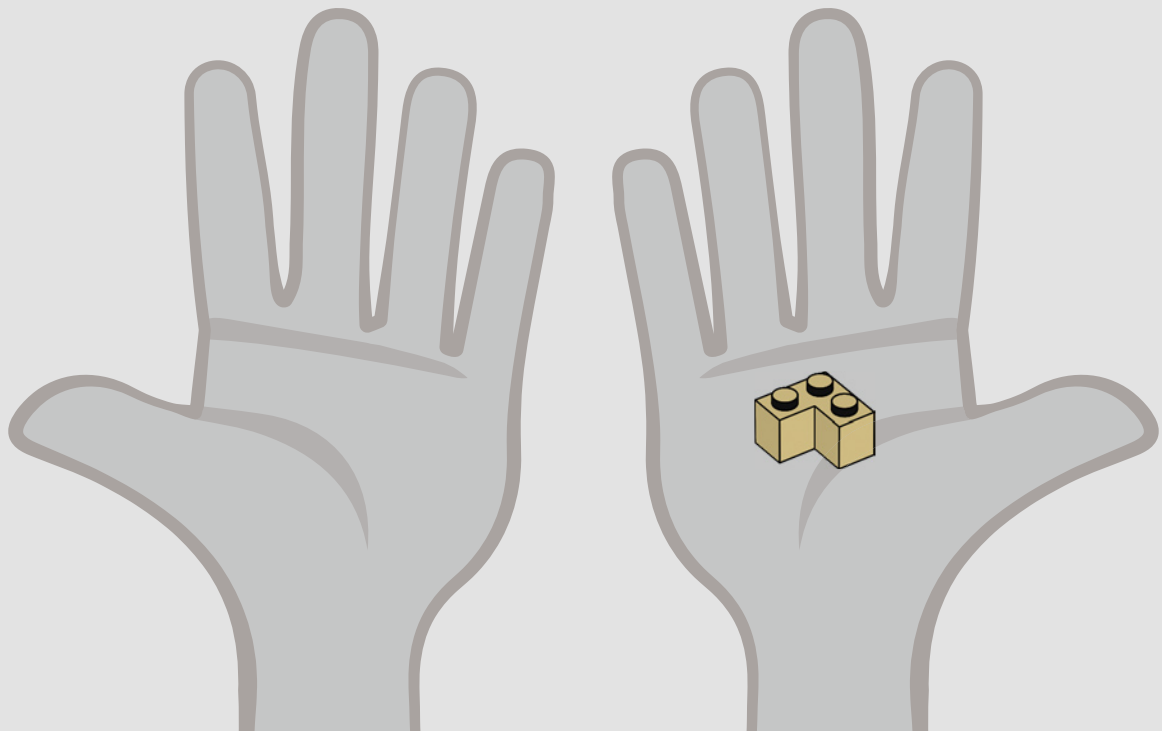

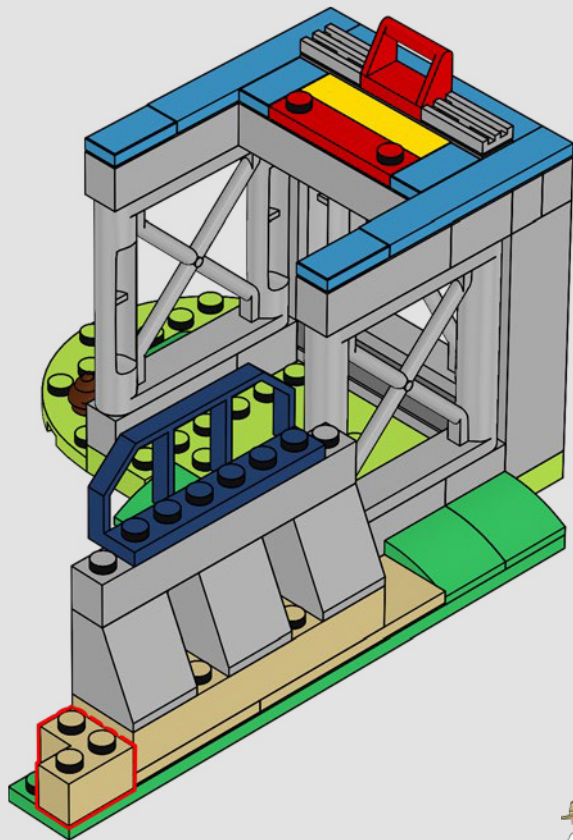

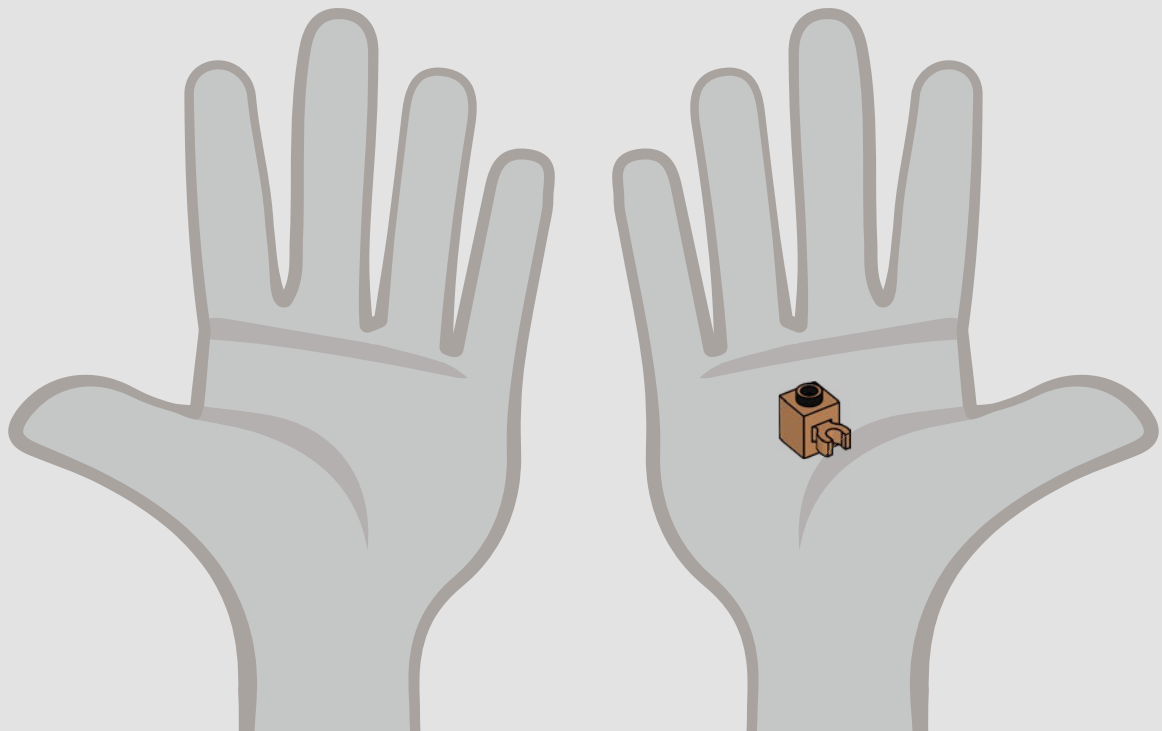

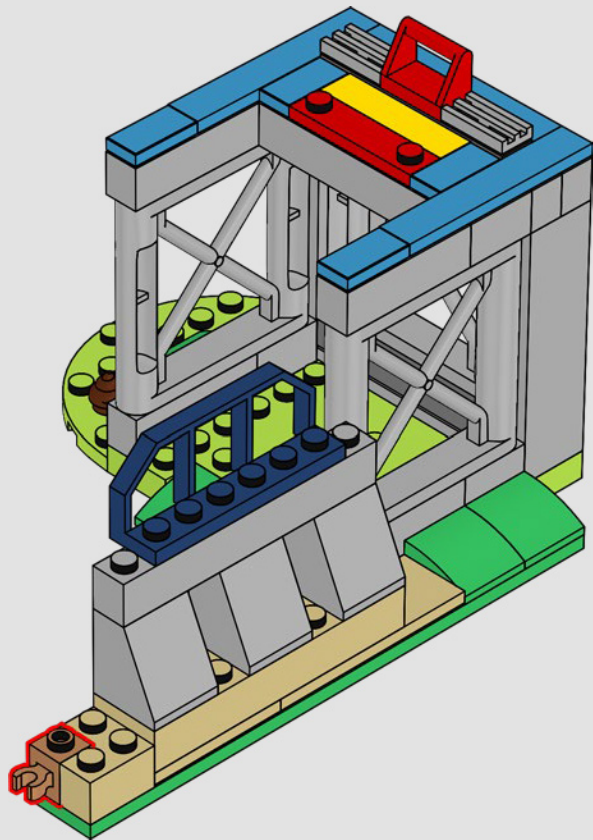

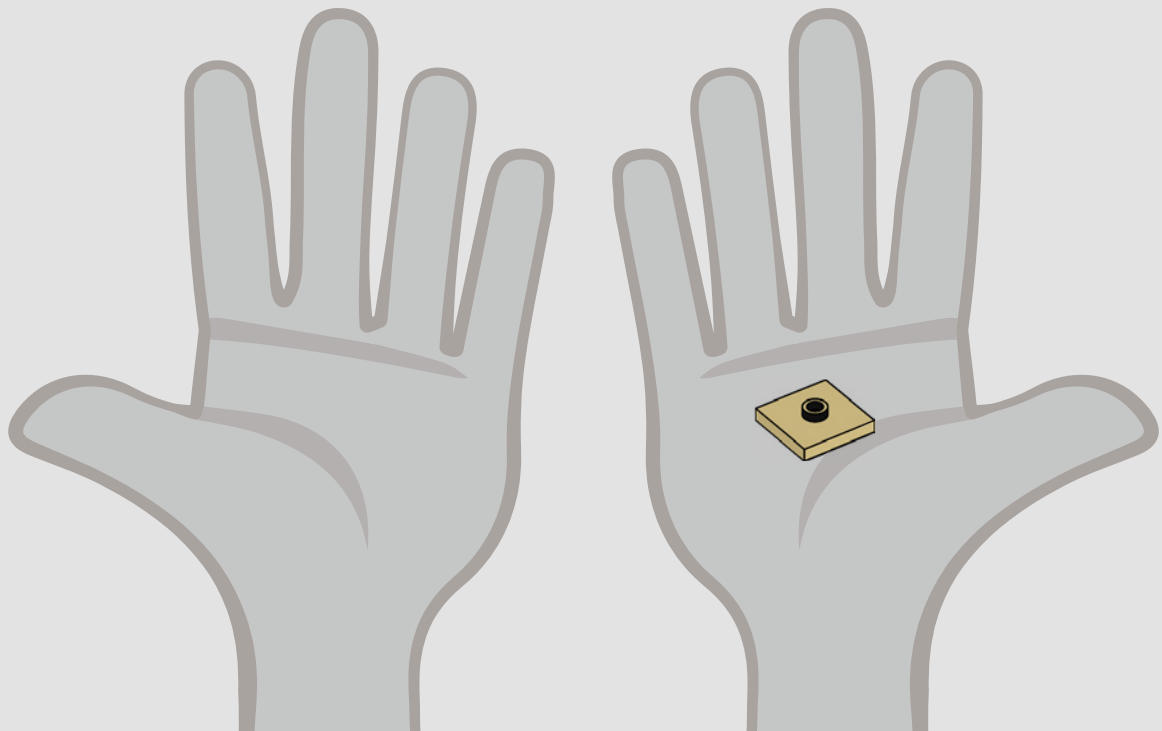

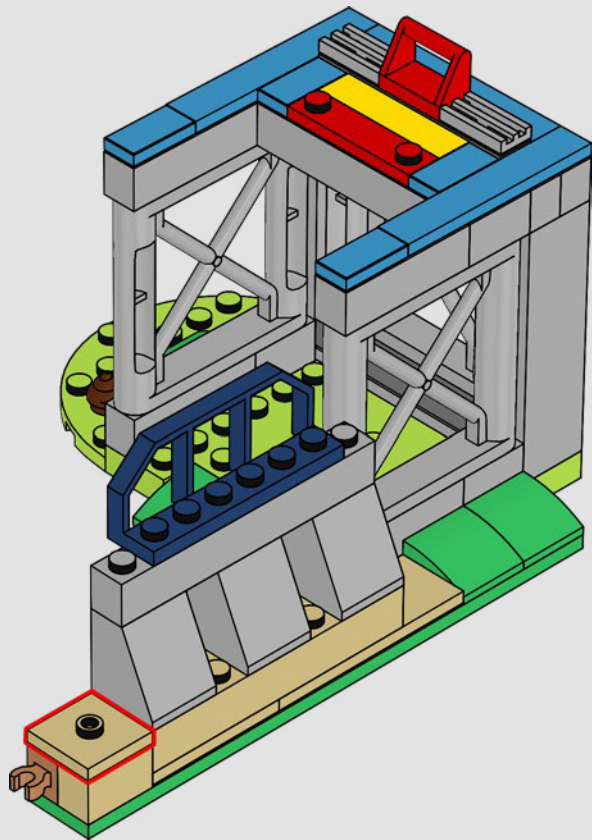

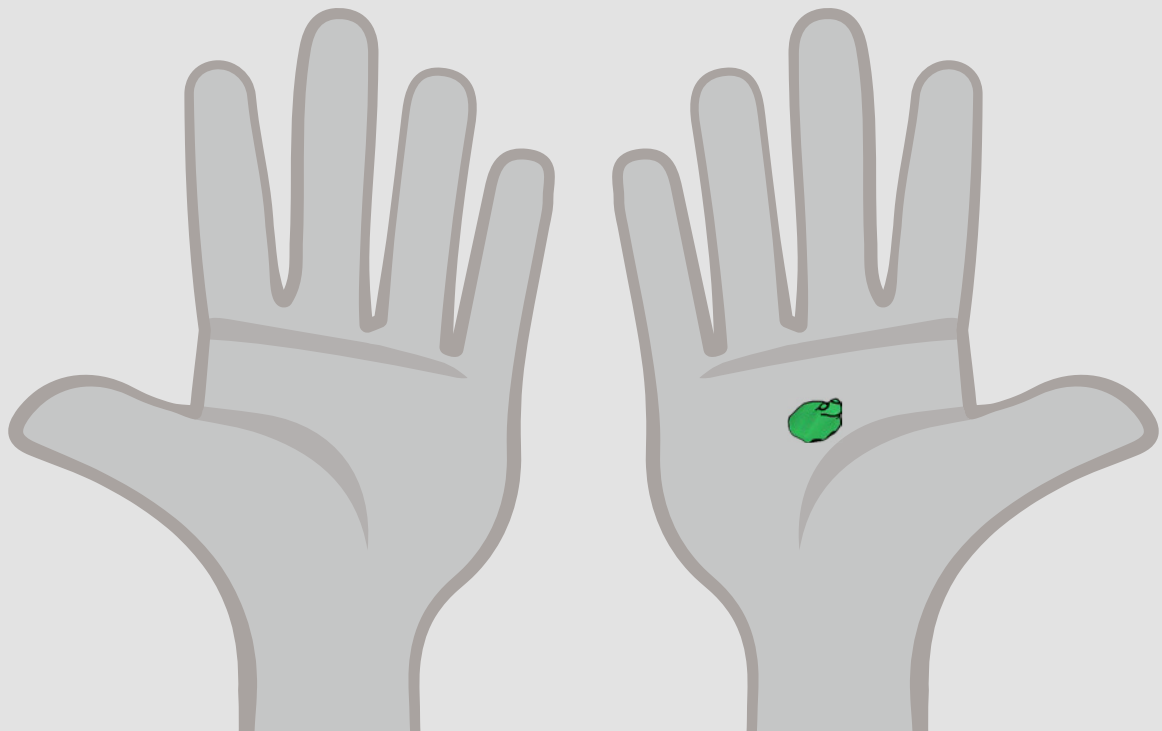

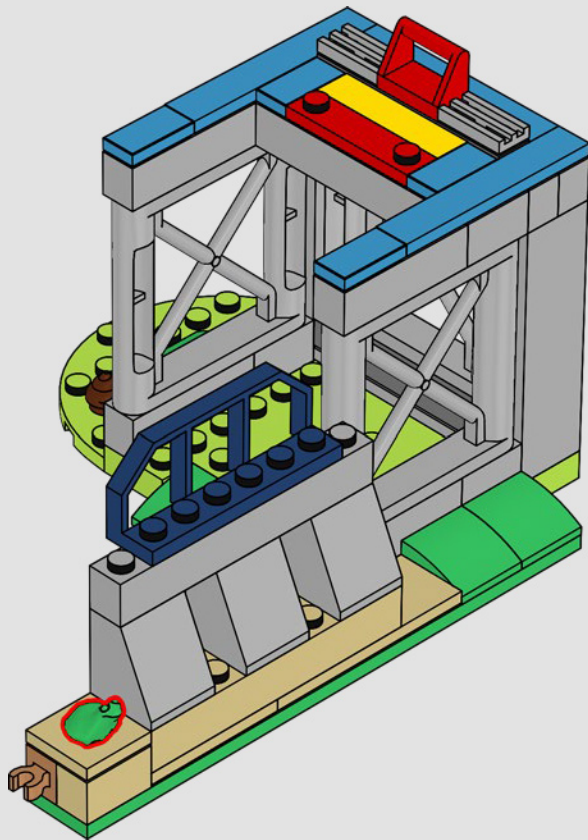

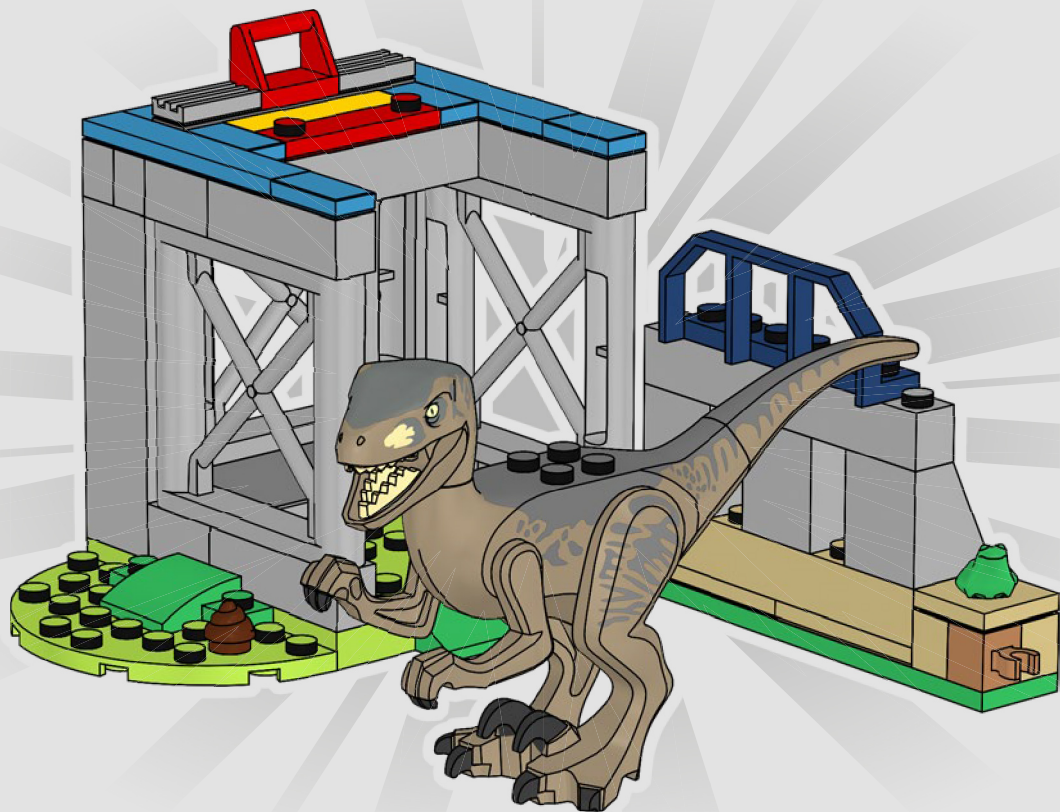





76961







1x
6343846



1x
6436248



1x
6436347



1x
302201



1x
6147214



1x
6436250



1x
6148262



1x
4540107



1x
6226564



1x
4124455



1x
4565387



1x
6440983

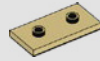

1x
6294227

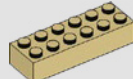

1x
4181134



1x
6331158

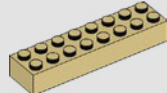

1x
6037398



1x
6144805



1x
243221



1x
6439748



1x
6256923



1x
6361953



1x
6436348



2x
6117938



1x
6223076



1x
6308099



1x
243124



1x
6424448



1x
379524



1x
6170545



2x
6279875



1x
6010831



1x
4226995



4x
4568644



1x
6171101



7x
6116259



1x
302028



1x
303428

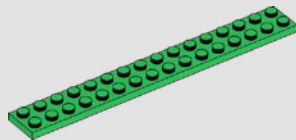

1x
6305835



1x
6360331



1x
6258607



1x
6441256



1x
6025026



1x
6056291



1x
6133225

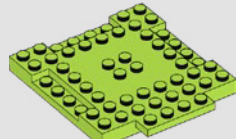

1x
6055164



1x
6132767



1x
6436288



1x
6436292



1x
6436289



1x
6251291



1x
6436290



1x
6436291



1x
6436287



1x
6436286



1x
6025376



1x
6037886



2x
6351912



2x
6439749



2x
4585479



2x
6212204



1x
6438899



2x
4211389



4x
4211764



3x
4211350



2x
4211388



1x
4654580



1x
6343889



6x
4234535



2x
6408022



4x
4211394

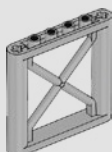

3x
6440545



1x
4211549

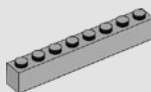

3x
4211392

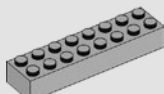

2x
6037399

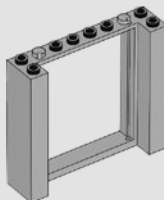

2x
6439743



1x
6347464



1x
6191976



2x
4211100



1x
6258887



1x
4549990



1x
6338817



1x
6436246



2x
6360035



1x
4569382



1x
6177189



1x
6350413



1x
6197966



5x
6151659



1x
6444291

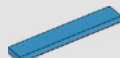

3x
6164336

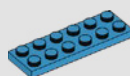

1x
4640891



1x
6301450

 [LEGO.com/service](https://www.lego.com/service)



YOU COULD
WIN



Scan this QR code or go to
LEGO.COM/PRODUCTFEEDBACK and give
us your short feedback about this LEGO® set
for a chance to win a cool LEGO prize.

Terms and Conditions apply*

EN: YOU COULD WIN. Terms and Conditions apply* **DE: Du könntest GEWINNEN.** Es gelten die Teilnahmebedingungen* **FR: Tu pourrais GAGNER.** Des conditions s'appliquent* **IT: Potresti VINCERE tu.** Termini e condizioni sono applicabili* **ES: Puedes GANAR.** Aplican términos y condiciones* **PT: Poderá GANHAR.** Aplicam-se termos e condições* **ZH: 轻松获奖. 条款和条件适用*** **PL: Szansa na WYGRANĄ.** Obowiązują warunki korzystania* **CS: Máte šanci VYHRÁT.** Platí všeobecné smluvní podmínky* **SK: Máte šancu VYHRAŤ.** Platia všeobecné zmluvné podmienky* **HU: TE IS NYERHETSZ.** Felhasználási feltételek érvényesek* **RO: Ai putea CÂȘTIGA.** Se aplică termenii și condiții* **BG: Можете да СПЕЧЕЛИТЕ.** Има определени правила и условия* **LV: Tu vari LAIMĒT.** Ir spēkā noteikumi un nosacījumi.* **ET: Sul on võimalus VÕITA.** Kehtivad tingimused* **LT: Jūs galite LAIMĖTI.** Taikomos sąlygos*

*[LEGO.com/productfeedback-terms](https://www.lego.com/productfeedback-terms)

LEGO and the LEGO logo and are trademarks of the LEGO Group. ©2023 The LEGO Group.

© Universal City Studios LLC and Amblin Entertainment, Inc. All Rights Reserved.

6500728